

Meeting the Challenges!

On November 26th, we saw the first snow at the FRM II this winter. But work doesn't stop and therefore, the next step of our current construction project, the structural work for the future connection building between the reactor building and the Neutron Guide Hall East will be finished by the end of this year.

Meanwhile the temporarily placed containers to overcome the urgent needed office space are increasing in number and sites. We even rented additional office and laboratory space at the neighbouring Max-Planck Institute for Plasma Physics. All these moves are made in order to pave the way for starting the construction of two new office and laboratory buildings on site of the FRM II. Preparatory work including the construction of a passable supply route will start in spring 2014. Shortly afterwards, the demolition of the existing old laboratory buildings (dating from the late fifties) will take place.

And we are not the only ones who are busy constructing. Just in front of the FRM II, the demolition work for the central conference centre at the campus started in the middle of November. In addition, preparations will be made for the new students' canteen and the new Institute for Laser Physics CALA.

So be prepared when you visit the FRM II during the next years: There will always be something new to look at! This holds especially true for the upcoming instrumentation of our new Neutron Guide Hall East. As you might already know, we will have only about 50% of beam time in 2014 due to the maintenance break ten years after the reactor started operation and, in the following year, due to the extension of beam tubes for the Neutron Guide Hall East.

We are looking forward to meeting the challenges!



R. Bucher (FRM II)

Dr. Jürgen Neuhaus
FRM II Deputy Scientific Director

Jürgen Neuhaus



Content

Don't miss our Special Feature
Changing Places
pages 4-7

Instrumentation

PUMA	8
KWS Machines	10
KWS-1: Ready to Use!	11
TOFTOF	12
More Weight and Higher Security	13
12,3 Mio € for Research at the Neutron Source.....	14

Events

SLOPOS13	16
NINMACH	17
JCNS Workshop	18
17 th JCNS LabCourse.....	18
Workshop Single Crystal Spectroscopy.....	19
Open House at the FRM II.....	20
Highlights der Physik.....	20
Internal Science Meeting.....	21
TUC-MLZ Texture School@ FRM II	21
DENIM 2013	22
ICNS 2013	22

Science & Projects

ESS@MLZ	23
Unveiling the Past	28
Posi-Analyse.....	30
Neutronsources.org.....	32

Outside

KFN: A Strong German Commitment to the ESS is Needed!	33
--	----

Inside

Newly Arrived	34
Always be on the Safe Side!.....	35
A Guided Tour of the Atomic Egg.....	36

User Office

Two Successful Rounds of our New Rapid Access Programme	38
Always on Fridays..	38
Review of Proposal Round 17	39
Call for Rapid Access Proposals.....	40
Call for Proposals	41
Upcoming	42
Reactor Cycles 2014	42

Don't miss the Proposal Deadline
May 2nd, 2014
page 41

Changing Places - New Chances!

Six o'clock in the morning, your smartphone wakes you up by playing your current favourite song. Lying there, you think about the day you have to face. The same underground as every day will carry you to your working place, you will meet your colleagues you are staying with for years now. The canteen's menu? You know it already by heart. At three o'clock there will be a short coffee break as usual - and one of the team will offer his burned cookies - also as usual. In the evening you will do some shopping at the supermarket down the street, where you are a customer for a long time now.

That sounds boring? Yes, it may be - but that is daily life for the most of us.

But what about an adventure? What about going abroad? What about living in another city, working at a different place, coming to know new colleagues? If this makes you curious, you are surely interested in the employee mobility efforts at the MLZ!

Giving the green light

It started in 2009, when the Steering Committee of the Institut Laue-Langevin (ILL) met in Munich. Obviously, the idea of an exchange just appear out of the blue - nobody really remembers today whose initial idea it was. Elisabeth Jörg-Müller, secretary to the Scientific Director Winfried Petry at the research neutron source in Garching, thought about it and was thrilled. Her enthusiasm fell on fertile ground, and Winfried Petry as well as the former director of the ILL, Richard Wagner, supported it on the spot. Shortly thereafter, Mrs. Jörg-Müller learned that Mr. Guérin, head of the ILL finance department, and his assistant, Eliane Joly, agreed to participate in this project. It took some time to settle things - but then, in autumn 2011, the job could be done properly: Both women exchanged their desks for three months. This change became a big success, and therefore both of them were more than happy that in autumn 2013, they could repeat it, this time for a duration of two months.



Eliane Joly (left) discussing with Silvia Valentin-Hantschel at the MLZ.

Between finance department and general secretary

"Eliane from the ILL is back again!"

That was the news in the MLZ scientific staff meeting



Elisabeth Jörg-Müller enjoying a sunny winter's day at the ILL.

that is to be held each Tuesday. It was a very warm welcome applause because everybody remembered her and during the next days several colleagues paid her a visit at the secretary to have a chat. Mrs. Jolie speaks German fluently because she worked there for almost 15 years before going back to France and joining the ILL. Nevertheless, she enjoys the opportunity to perfect her language skills. At the MLZ, she works in the general secretary and carries out all the small and big tasks and solve the problems that incur there. She is not alone there: Her colleague Silvia Valentin-Hantschel, is happy to support her - and the laughter you sometimes hear when opening the secretary's door indicates a quite good relationship!

At the ILL, Mrs. Jörg-Müller does Mrs. Joly's job alone. In 2011, Mrs. Jolie trained her on the job for two days, and introduced her to several colleagues. This time, she visited the ILL in summer and got an update about any changes of the situation two years before. Nonetheless, both women prepared exhaustive descriptions for each others, what to do in the different cases. From their first exchange, they learned that this is really helpful. Furthermore they have to document their work, because afterwards the other one has to take over and for example has to be informed about any agreements the other one reached. but both agree, that this is no problem once you are used to.

At the *Service Financier et des Achats*, Mrs. Jörg-Müller takes over on the one hand tasks of a secretary, and on the other hand administrative tasks, like dealing with continuous contracts and therefore working with the enterprise applications used at the ILL. By the way: She speaks French fluently and is - like Mrs. Joly - really happy to get the possibility to improve her skills by working with native speakers.

Both of them enjoy the exchange because thus they escape some kind of a treadmill. They got and get insight in somebody else's job and this helps to see the own job from a little distance.

And what about the administrative preparations? The secondment of personnel has to be approved and the institutions have to agree about the exchange. In principle, they have to do all the things they would do when hiring



Institut Laue-Langevin at night.

a new staff member.

Both of them stay at a hotel, one located in the inner city of Grenoble with a nice mountain view, the other one in Garching, close to the underground, taking you either to Munich or the FRM II. They took the opportunity to explore the surroundings. For example, Mrs. Jörg-Müller often hikes in the mountains or visits a museum and Mrs. Joly meets friends from her time in Germany.

And what do they learn for themselves? Mrs. Joly and Mrs. Jörg-Müller agreed:

“You have to leave behind everything and everybody you know and that is a challenge at first sight. You have to integrate into a new team and into unknown working methods. But then you realise, that after a few days, these are no big deals, because you can always ask somebody for support. And that is when you get new ideas how to improve your own work, what is really valuable.”

Interacting scientists

Henry Fischer, born American, naturalized French, and working in France since 1992 after a postdoctoral position in Montréal (Canada), learned about the possibility to change desks with an MLZ scientist from a presenta-



Henry Fischer visiting the MLZ User Office for a little chat.

tion given by Helmut Schober, the Associate Director of the Science Division at the ILL. Henry joined the ILL in 1994 and is presently responsible for the D4 diffractom-



Robert Georgii, still at the MLZ.

eter for disordered materials. His tenure at the ILL was interrupted for about five years when he worked as a professor of physics at Université Paris-XI (Paris-Sud). With such a life story, he was just right for the project. Very interested from the first moment on, he volunteered to be the first scientist participating in the exchange between the two big European neutron research centers. That could seem a bit adventurous, because he had never visited the MLZ before, not even as a user. But as he had hoped, he was welcomed at the MLZ by friendly enthusiastic members of the international neutron-scattering community. He sees his stay at the MLZ not only as an interesting personal and professional experience, but also as a small contribution to the relationship between two neutron-scattering centres:

“The international neutron-scattering community is a precious asset that we should work to support and develop. Scientific collaboration is ultimately a social endeavour, especially at large central facilities like the ILL and the MLZ, and in general, breadth of personal and professional experience leads to breadth in per-



The view from above the Rütli on Lake Uri (Lake Lucerne).

spective, and thus to more positive, creative and effective scientific collaboration.”

Based on his experience at the ILL, Henry was associated to the Time-of-Flight instrument TOFTOF, but he also has the opportunity to perform experiments at other MLZ instruments. At the moment, he is doing a spin-echo experiment with the RESEDA team, and next January he has an experiment planned at SANS-1.

He has enjoyed his stay at the MLZ from the very beginning. In December 2012, he visited Garching for the first time and was treated to a well-planned introduction to the research facilities and made first acquaintances. When he started on the 1st of September, 2013, it was Elisabeth Jörg-Müller who made his first days easier. Having already participated in an ILL/MLZ exchange, she was well aware of what needed to be done: she not only organised his stay at a hotel apartment in Garching, but also introduced him to many colleagues. Henry remains impressed by how easy the preparations for the exchange were made for him. He just filled out and signed a couple of documents and everything else was taken care of by the ILL and MLZ administrations.

Once arrived, it was easy for him to make new friends and for example to join them for the daily lunch break, where he enjoys the stimulating variety of conversation topics in German. Henry tries to compensate his lack of talent in learning foreign languages by enthusiastic participation whenever possible. Although he has been studying German off and on for 30 years, this is the first time that he has had the opportunity to practice it fully, and he appreciates the patience of his MLZ listeners. In any case, due to staff members coming from all over the world, everyone at the MLZ can speak English, which makes it really easy for colleagues who don't speak German. So this shall not be a hurdle for anybody interested in changing desks!

Henry Fischer will stay for eight months. His wife has already visited him and they spent an afternoon at the famous *Oktoberfest*, sampling some German Bratwurst

and Bavarian beer. They also made a brief trip along part of the *Romantische Straße*, a famous theme route between Würzburg and Füssen in southern Germany, linking a number of picturesque towns and castles.

“As an avowed francophile, I am pleasantly impressed by the quality of life in Germany.”

And what about his exchange partner? The situation is a little bit different from that of Elisabeth Jörg-Müller and Eliane Joly, who exchanged their positions at the same time. Robert Georgii, instrument responsible at the multi-purpose instrument MIRA will join the IN12 team, a three axes spectrometer, at the ILL from June 2014 on. He will stay there for four months and is looking forward to returning to France: He had been to the ILL for three years in the early nineties. He also already knows his future team because he did experiments as a user with them before. At the moment he prepares several proposals for the next deadline at the ILL in order to gain the possibility to carry out experiments at different instruments. What is his motive to participate in the exchange project?

“I have worked at the MLZ for around ten years now. I love my job, the contact to the users, the maintaining of the instrument. But there is always a time when you have to not be restricted in your thinking. Therefore I



Sybille Komposch of the UCN Physics group at PSI shows Katharina Bulla round the SINQ target hall.



The Heinz Maier-Leibnitz Zentrum at Garching.

was really happy when I learned about the possibility to get to the ILL. I am convinced that participating in the daily life of the instrument responsables there will give my work at the MLZ new impetus.”

Off the river Isar to the river Aare

Trainees on internship at PSI

Not only staff members of the administrative and scientific divisions are interested in a change of scene. Katharina Bulla and Florian Jaumann are trainees at the mechanical workshop of the FRM II. Their adventure took place in the summer of 2013. But let's read about it in their own words!

The first contact to the Paul Scherrer Institute (PSI) was made by Axel Pichlmaier (FRM II) and this helped us to organize an internship in Switzerland. We received financial support from the Erasmus programme and so we could start by car to Kleindöttingen, Switzerland in mid-June.

On Monday morning, Michael Meier, scientist in the UCN Physics group, was waiting for us and received us warmly at PSI. In the following days he and his colleagues showed us the whole area and allowed us to participate on a guided visitor tour with an emphasis on the Switzerland Synchrotron Light Source (SLS). The excellently organized material storage and workshop for general use inspired us as well as the experimental hall, the Cock-



Michael Meier and Florian Jaumann in the workshop at PSI.

croft-Walton pre-accelerator and the famous proton accelerator (cyclotron).

Michael Meier already had prepared several projects for us at the instruments of the ultra-cold neutron source (UCN). We worked with the mapper, which we newly built up and calibrated in the hall to perform a test run outside of the experiment. We even were allowed to work on the neutron guides, for example, glue the adjusting rings and help to coat the neutron guide with the self-designed sputter factory. Furthermore, we helped with the wiring of some magnetometer with optical waveguides.

During the two weeks in Switzerland, we of course have not learned real *Schwyzerdeutsch*, but the Swiss colleagues made great efforts to speak standard German with us. We were able to train our English language skills with the other colleagues as e.g. from Poland or India.

In our free time we could borrow bikes from the PSI and do some tours along the Aare or to Baden and Ruine Stein. On the weekend we visited the Heart of Switzerland and took a hike to the Rütli on Lake Lucerne.

For us, the two weeks at PSI were a big win, because we got insights into other ways of working and strengthened our professional and social skills. We would like to thank all those, who made this internship possible: the motivated staff at PSI, Michael Meier and his colleagues, and Axel Pichlmaier (FRM II), especially Klaus Kirch (PSI) and Anton Kastenmüller (FRM II), who accorded and supported our study abroad.

If everything goes well, both trainees will get the opportunity to visit the ILL next year. Furthermore another pair of scientists will change desks.

Everybody at the MLZ is encouraged by the directorate to consider such an exchange. The participants up to now concur that it they gain so much from a personal as well as professional point of view.

So, just think about it, maybe tomorrow morning at six o'clock!

Put together by I. Lommatzsch (FRM II)

The Multianalyzer System at PUMA is Online

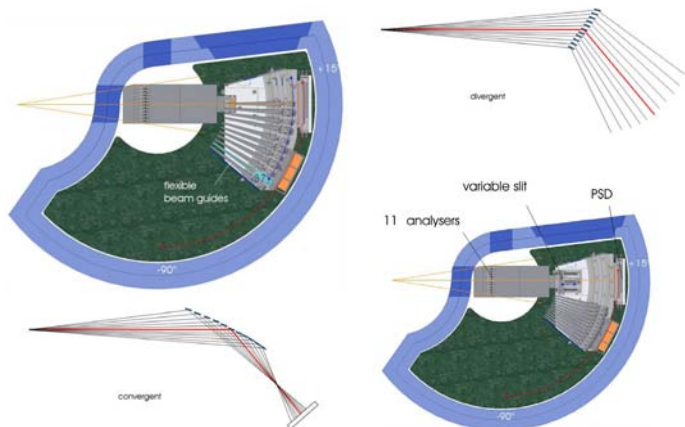

Fig. 1: Secondary spectrometer of PUMA using the multianalyzer system in convergent mode with position sensitive detector (left) and in divergent mode using single detectors (right).

PUMA – the thermal three axes spectrometer built and operated by the Georg-August-Universität Göttingen – is characterized by a number of outstanding features and novel techniques not available anywhere else. The efficient use of the neutron beam thanks to the optimisation of individual components and focussing techniques makes it one of the most powerful and versatile instruments worldwide.

From the very beginning the exploration of new techniques was one of the most important issues during the instrument development. As a new highlight, the unique multianalyzer system is now going online. It provides new possibilities for mapping of excitations, and, in particular, for time-resolved kinetic experiments which aim at the determination of excitations that vary during processes like chemical reactions, demixing, phase transitions, switching of ferroelectric or multiferroic systems etc. Complementary to stroboscopic techniques which are applicable to reversible processes, the multianalyzer approach allows the investigation of dynamical properties on a time scale of seconds in single shot experiments.

A conventional three axes spectrometer allows the point by point exploration of scattering intensity in the 4-dimensional momentum- and energy- ($Q-\omega$)-space by varying

- the incident energy of neutrons (by rotation around the monochromator axis),
- the energy of scattered neutrons (by rotation around the analyzer axis), and
- the scattering angle (by rotation around the sample axis).

PUMA is now equipped with eleven individual analyzer channels that can be configured according to the user's

needs. Hence, it works as a collection of eleven individual instruments in parallel and allows to reduce the counting time accordingly.

Fig. 1 shows the setup of the secondary spectrometer. Eleven analyzers (graphite 002) can be positioned independently to reflect neutrons of different and well-defined energies which are subsequently detected by eleven individual ^3He -detector tubes. In order to avoid crosstalk between the different beam paths, the detectors are equipped with guides acting as collimators. Detectors move around the analyzers, and guides are rotated independently to point to the associated analyzer crystal which can be translated in order to optimise the beam configuration. The entire system thus consists of 44 individual axes (translation and rotation of analyzers and detectors) which are driven by stepper motors using a compact electronic control system developed at the home institute. During the commissioning phase of this demanding system, it was proven that the required extremely high mechanical accuracy and reliability is indeed achieved.

While the configuration with eleven individual detectors seems to be the most flexible setup, converging modes as shown in the left part of fig. 1 might also be advantageous for particular experiments. Hence, the system is completed by a position sensitive detector (consisting of seven horizontally arranged ^3He -PSD-tubes) that moves around the analyzer centre. In this case, an adjustable slit between analyzers and detector helps to reduce background and crosstalk.

The flexibility of the multianalyzer system allows experiments with a broad range of different configurations. The aim is to find the most convenient configuration for a

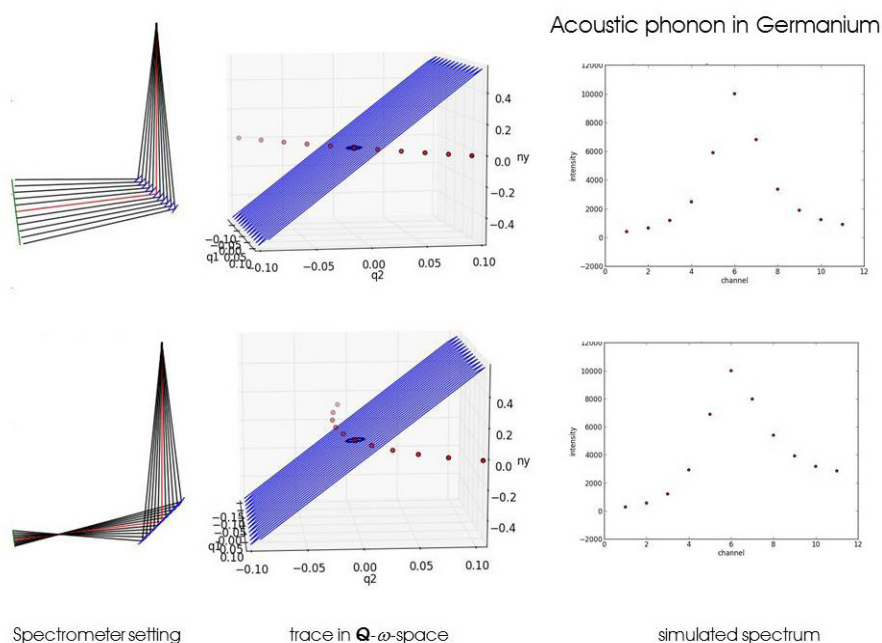

Fig. 2: Example for the graphical representation of different configurations for the determination of a TA-phonon in germanium as provided by the software package.

scan across a particular excitation in $(Q-\omega)$ -space which is realized by a single setting of the multianalyzer. Obviously, the popular constant- Q -scans can not be realized, but an optimised scan path can be found which allows the determination of well-defined phonons or magnons, for example. This new method of multi-axes spectroscopy requires some deep insight into the behaviour in direct and reciprocal space.

In order to assist the users, a quite general software package was developed exploring fully automatically the abilities of the multianalyzer system. If the user has any idea about the excitation frequency at a particular scattering vector and a possible orientation (and curvature) of the dispersion surface, the program finds the most suitable configurations of the multianalyzer and the user does not need to take care of the device's details.

Criteria defining the optimization process are for example:

- scan direction should be almost perpendicular to the dispersion surface,
- scan range should be adapted to the resolution of the spectrometer,
- spurious peaks due to higher order reflections at monochromator or analyzer should be avoided.

The used general resolution program takes into account the focussing effects in direct and reciprocal space and allows the simulation of spectra based on the full 4 dimensional resolution ellipsoid before they are actually measured. Fig. 2 shows some examples of the program's output.

Test experiments on some model systems like germanium or quartz were performed. They show quite nicely that an entire phonon scan can thus be obtained within some seconds. As an example, the result of a multianalyzer scan across the TA-phonon of germanium with a total counting time of 1 s is shown in fig. 3. It demonstrates

Variation of k_x

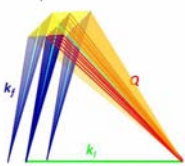

Variation of scattering angle φ

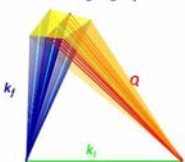

Variation of sample angle ψ

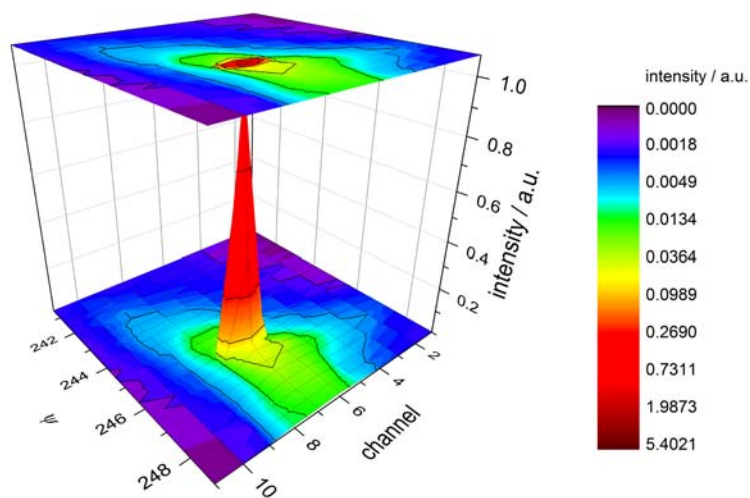
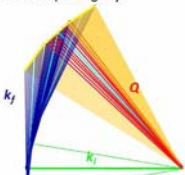

Fig. 4 : Different simple mapping modes (left) and mapping of the LA(0.2 0.2 0)-Phonon in germanium using a sample rocking (ψ) scan (right).

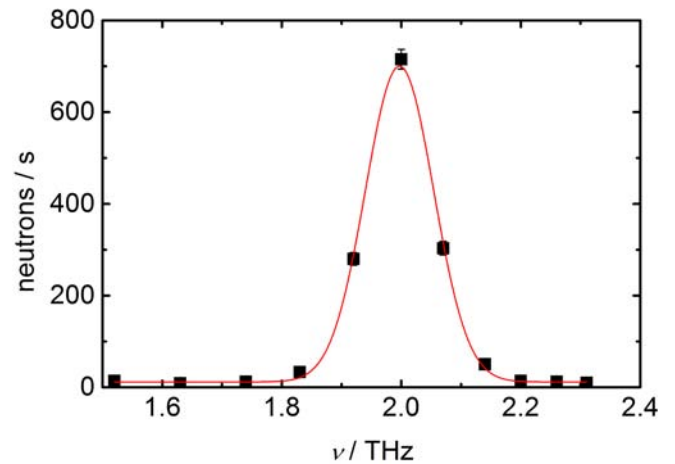

Fig. 3: TA (0.4 0 0) Phonon in Germanium obtained with a total counting time of 1 s.

the ability to perform inelastic kinetic experiments in single shots on this hitherto not accessible short time scale. While mapping of excitations is not the main topic of the PUMA-multianalyzer, it nevertheless can be realized in different ways. Once the multianalyzer is configured, different simple and fast scans allow to map an area in $(Q-\omega)$ -space: As shown in fig. 4, a variation of the sample angle ψ (rocking scan), the scattering angle ϕ or the incident wavevector k_i cover different parts of the reciprocal space.

A thorough testing phase of the multianalyzer at PUMA showed that the mechanics and electronics as well as the software and simulation work fine. Now it is up to the users to explore the specific advantages of this new multiplex method which might open a new field of applications.

*O. Sobolev, R. Hoffmann, V. Meyer, G. Eckold
(Georg-August-Universität Göttingen)
N. Jünke (TUM)*

The PUMA-project is funded by the German Federal Ministry of Education and Research.

Structural Changes under Controlled Humidity Conditions

New sample environment at KWS SANS diffractometers

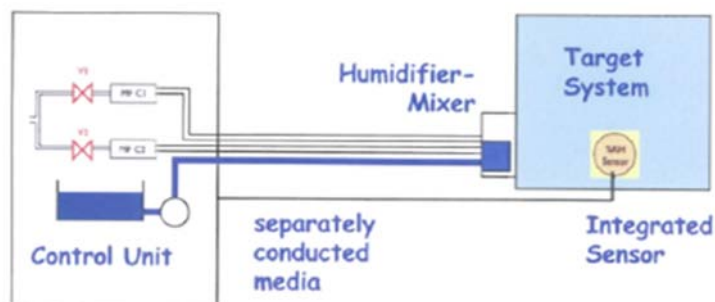
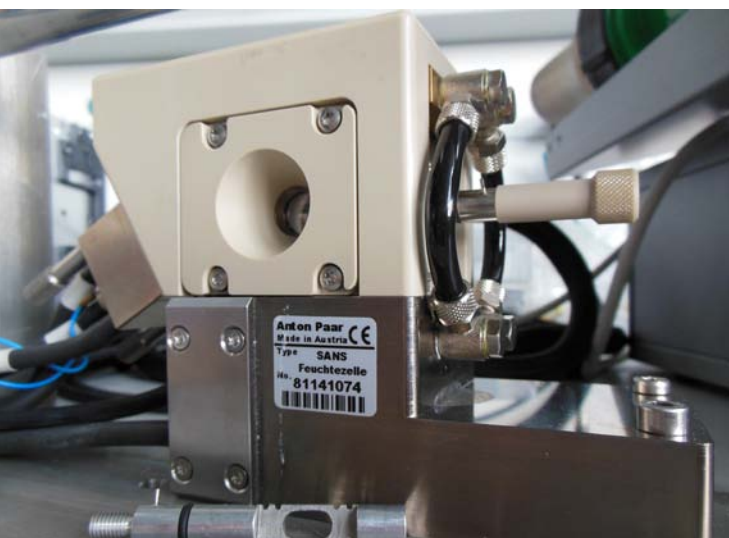

Fig. 1: A photo of the new humidity chamber (left) and its functional diagram (above).

Because of its unique properties water drives many biological and chemical processes [1,2], just to mention some of them: hydrolysis, photosynthesis, or proton conductivity in low temperature proton exchange membranes for fuel cells (PEMs). In the latter case, it is well known that conducting properties of PEMs strongly depend on the water available in the system, because the transport of protons and water takes place in the hydrated hydrophilic domains.

Several small-angle neutron scattering (SANS) studies deal with structural characterization of various proton exchange membranes by trying to correlate the very complex structural features with proton conductivity and membrane functionality, but in fully hydrated (bulk water) state [3,4,5]. Following how the water distribution and the proton conducting channels are changing when

water is released in a controlled manner from the membranes can give more information enabling better understanding of the intricacies of the conducting properties of PEMs. This enhanced understanding will make easier better designs of cheaper and more effective PEMs.

In order to keep up with the new scientific requirements from the side of sample environment, a humidity chamber has been purchased from the company Anton Paar GmbH. The device works on the gas flow principle (fig. 1), it controls the relative humidity by mixing different ratios of fully hydrated and dry inert gas (usually dry air). The regulation is made according to the feedback from the humidity sensor installed in the vicinity of the sample. The device enables a continuous humidity control from 5% to ~95% relative humidity (R.H.), while the temperature can be adjusted between 10 - 60°C. Different types

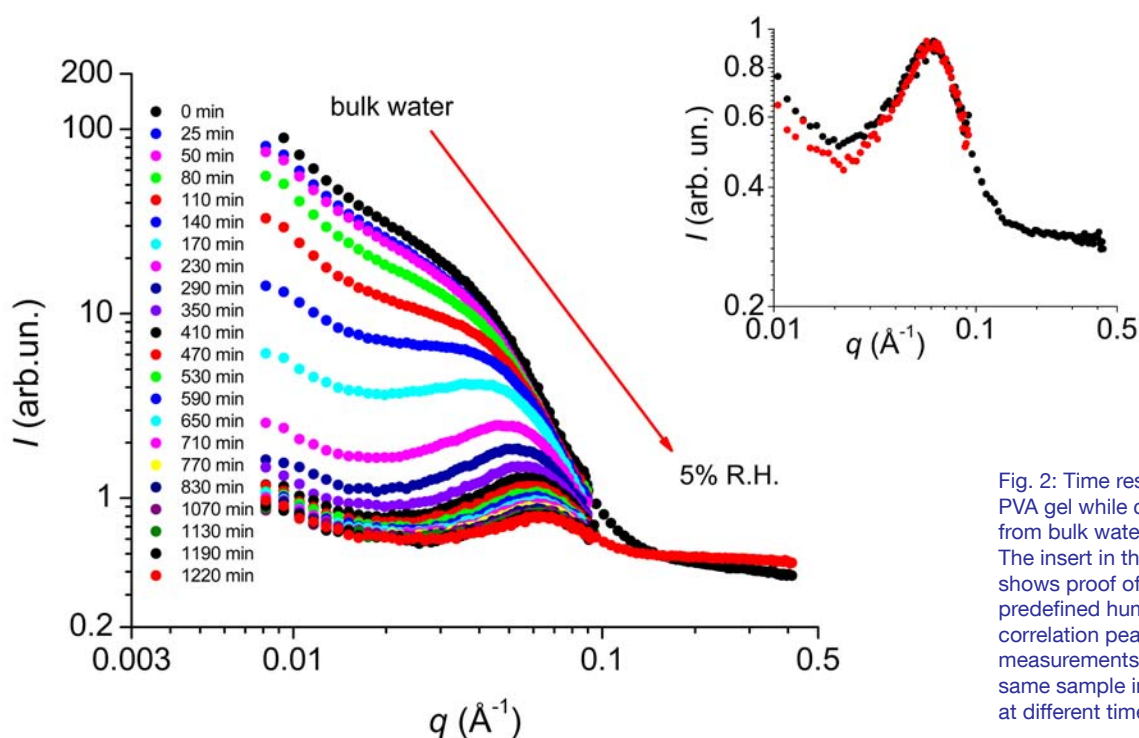

Fig. 2: Time resolved SANS on wet PVA gel while changing the R.H. from bulk water state to 5% R.H. The insert in the right upper corner shows proof of reproducibility for the predefined humidity. The position of correlation peak is constant for two measurements performed on the same sample in identical conditions at different times.

of sample holders allow for the measurement of small powder, liquid or solid (film like) samples. This type of setup facilitates a fast equilibration of the predefined humidity values and easy R.H. and temperature changes on the samples. The short response times, in addition to the high neutron flux of the KWS diffractometers, make it possible to follow the structural changes in real time during wetting/ drying processes. These measurements aim to correlate diffusion kinetics and/ or water sorption/ desorption isotherms to the structural changes occurring in the samples.

The reliability and stability of the humidity chamber had been verified with time resolved SANS measurements on polyvinyl alcohol (PVA) cryo-gels. PVA cryo-gels show complex hierarchical structures [6,7] which were sensitively dependent on the changes in the R.H. Structural reorganization induced by D₂O vapor uptake and release was investigated under controlled humidity conditions (fig. 2).

In order to check the reproducibility of the predefined humidity values the water uptake measurement (going from 5% R.H. to 95% R.H. at 25°C) of one sample was repeated twice. The correlation peak was observed in

the same position both times, proving the reproducibility and reliability of the device (fig. 2).

Using the humidity cell in SANS studies can be an appropriate approach in better understanding the changes in the physical properties of membranes due to small changes in the hydration degree.

N. Szekely, H. Schneider (JCNS)

References

- [1] Chem. Rev. 100 (2000) 2013–2045.
- [2] J. Molecular Structure 322(2) (1994) 1–25.
- [3] Journal of Membrane Science 243 (2004) 317–326.
- [4] Macromolecules 33 (2000) 4164–4171.
- [5] Macromolecules 41 (2008) 2271–2277.
- [6] Chem. Matter. 17 (2005) 1183–1189.
- [7] J. Phys. Chem. B. 111 (2007) 2166–2173.

KWS-1: Ready to Use!

Upgrades successful

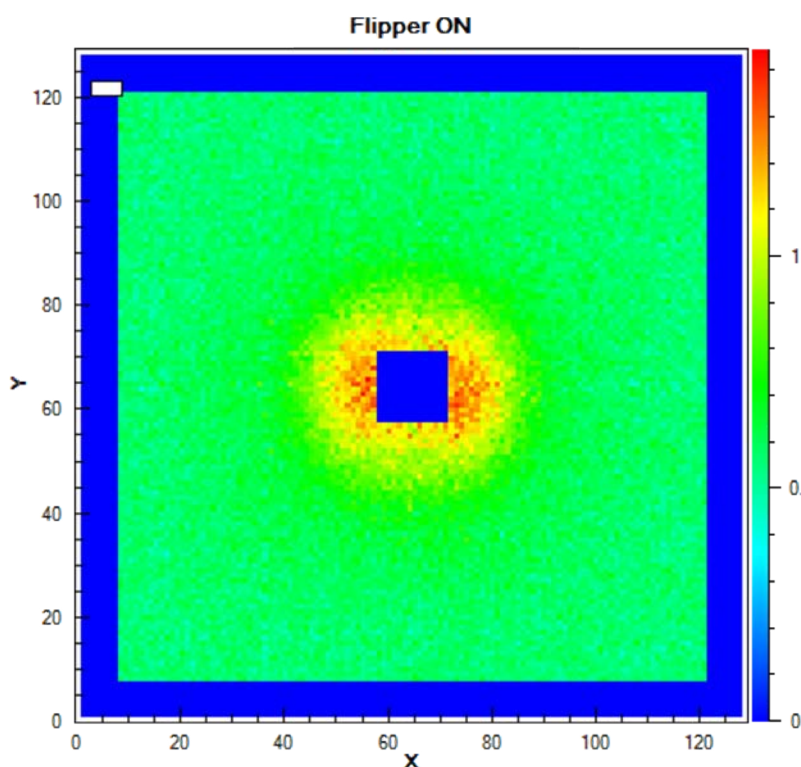

The first detected polarized neutrons at KWS-1 scattered from a magnetized ferrofluid sample. The neutron spin is parallel to the vertically applied magnetic field.

During the 33rd reactor cycle the newly upgraded small-angle neutron scattering instrument KWS-1 was commissioned. During this time all major parts of the instrument were tested for their functionality and reliability. The main attention was devoted to the precise calibration of the sample-to-detector distance as well as the instrument's velocity selector and a check of the absolute calibration at the instrument.

After those successful tests, the newly installed polarizer and its revolver changer was tested. Together with the radio-frequency spin flipper in the beginning of the collimation line and the analyzer at the sample position the efficiency of the polarizer was found to be close to the theoretical predictions. Precise value will be obtained using ³He cell as an ideal neutron spin analyzer. The commissioning of the chopper and neutron lenses, i.e. their tests from measurement software are planned. In the 34th reactor cycle KWS-1 is ready for experiments in the conventional SANS mode as well as for experiments with polarized neutrons.

We would like to acknowledge all the staff involved in the upgrade and commissioning of the KWS-1 from JCNS, ZEA-1 and ZEA-2 of the Forschungszentrum Jülich GmbH. We are thankful to the instrument scientists from MIRA for the given analyzer.

A. Feoktystov, Z. Di, S. Jaksch and H. Frielinghaus (JCNS)

Neutron Scattering at High Pressure

New scientific perspectives at the MLZ

The characterization of the physical and chemical properties of the condensed matter under extreme environmental conditions is one of the big challenges of nowadays and in the next future. Despite some unique peculiarities of the neutron scattering, however, the high pressure investigations at large scale neutron facilities have been significantly limited so far due to the big size of the typical samples and other further technical restrictions. As a matter of fact, even the existing high pressure equipments are far from being routinely operated and taken into account when designing a new line of research.

Any progress in this direction represents therefore a huge potential source of scientific development, whose technical feasibility is supported by the unprecedented results achieved in the field of focussing neutron optics over the last few years. Within this contest, we addressed the complex task under different complementary points of view: technical and technological aspects, scientific discussion and educational activities.



JCNS Laboratory course on Neutron Scattering: students using the hydraulic high pressure equipment installed at TOFTOF

Our main focus of interest is the TOFTOF instrument, which already hosts the first focussing device in the world for neutron spectroscopy combining the leading-edge supermirror technology with the adaptive neutron optics, suitable for a thermal-cold white neutron beam (1.4 – 14 Å). It is able to squeeze the beam cross section down to less than a squared centimetre, with an almost doubled signal-to-background ratio [1]. New hydraulic and gas high pressure cells came recently into operation up to 0.4 GPa and are being tested up to 0.7 GPa. The

GPa range is expected to be reached in the near future. In order to prepare the scientific community for these new opportunities, the notes of the JCNS Laboratory Course on Neutron Scattering have been integrated accordingly [2]. Particularly, at TOFTOF the students could take part to high pressure experiments, designed ad hoc for the understanding of the fundamental physics of the liquid state, along with the practise of the existing high pressure set-up.

On December 10th-11th, the MLZ hosted a *Technical Meeting on Neutron Scattering at High Pressure*. For this one and a half day kick-off meeting, we brought together several persons from different scientific areas, who are already involved in the high-pressure research and/or active in the European neutron scatterers' community:

- Karl Syassen (MPI Stuttgart)
- Rudi Hackl (Walther Meissner Institut)
- Konstantin Kamenev (Edinburgh University)
- Marie-Sousai Appavou (JCNS)
- Nicolas Walte (Bayerisches Geoinstitut)
- Christian Pfeleiderer (TUM)
- Chris Goodway (ISIS)
- Burkhard Annighöfer (LLB)

Topics of the talks and discussions were existing equipments and expertise (complementary techniques like X-ray and Raman scattering included), basic infrastructures as well as technical support required before, during and after the experiments. This includes the sample preparation and the cell loading, and related questions like the alignment of single crystals or the sintering of powder and pressure media in convenient pellet shapes. Great attention was also payed to the major safety aspects and the main issues for the equipment's proper handling. Finally, future perspectives like the employment of diamond anvil cells, the optical access to the sample during the neutron experiments and the possibility of in-situ complementary measurements (e.g. magnetic susceptibility or calorimetry) were discussed.

The gained information will be collected in a technical document providing a rational base for any further MLZ scientific discussions in this field, including the request of financing *Neutron Research at High Pressure*.

G. Simeoni, A. Buchner and J. Peters (FRM II)

References

[1] G.G. Simeoni et al., Focusing Adaptive Optics: Neutron Spectroscopy under Extreme-Environment conditions, in preparation

[2] G.G. Simeoni in *Neutron Scattering – Experimental Manuals of the JCNS Laboratory Course* Vol. 64 (2013)

More Weight and Higher Security

Works performed in the maintenance break

Prior to the start of the 33rd reactor cycle a longer maintenance interval of 45 days was completed, in which a number of works had been performed.

The company Kraftanlagen München welded, supported by the staff of the FRM II, an additional, second major check valve in the primary cooling circuit. In 2009, the main check valve had not fully closed and thereby caused a reportable event. The check valve's function is to stop the backflow of water in the case of emergency cooling of the fuel element. Further four angle check valves had acted until the modification as the only redundancy of the main check valve. To have another backup, the installation of an additional second check was planned. This installation could now be completed in the maintenance break in summer 2013. Because the check valve weighs more than 500 kg, extensive preparations as well as conversion work on the primary cooling circuit, and various examinations were necessary.

In addition, the previously only 2 t carrying freight elevator in the reactor building was replaced by a new hydraulic elevator with a lifting capacity of 10 t. 721 special dowels had to be installed in order to attach the new rails



Fig. 1: The new second check valve.



in the elevator shaft. The higher capacity of the elevator is imperative in order to transport the radiation shielding for the targets of the future molybdenum-99 production. The new extended weight limit will also reduce the transports through the port in the ceiling between experimental hall and reactor hall, affecting PANDA.

Another measure in preparation for the Mo-99 production line was the welding of additional pipes in the secondary cooling circuit for the connection of the Mo-99 irradiation facility's future cooling cycle.

Furthermore, the compressor motor of the cold source was equipped with a frequency converter to compensate for fluctuations and span very short-term failures in the external power supply. This will improve the reliability of the cold source and prevent shutdowns of the whole neutron source due to external fluctuations in the power supply.

Good news from the evaluation of the measurements for the C-14 charges for the first half of 2013: It shows that the very low annual limit for C-14 has been exhausted only to about 15%. Since during this period also the cleaning resins of the moderator cycle were dried, this value shows that the measures taken to reduce the C-14 charges are effective and an approach to the annual limit for 2013 is not expected.

A. Kusterer (FRM II)



Fig. 2: Inside the upgraded elevator shaft (above).

One of the 721 special dowels. (right).



12,3 Mio € for Research at the Neutron Source

The German Ministry for Education and Research (BMBF) supports again the construction and development of scientific instruments at the Heinz Maier-Leibnitz-Zentrum (MLZ).

The support originates from the BMBF programme *Erforschung kondensierter Materie an Großgeräten* and will stimulate the research of eleven universities at the MLZ for the upcoming three years.

Dieter Richter and Winfried Petry, the scientific directors of the MLZ, are satisfied:

“The research with neutrons at the MLZ addresses the grand challenges of our society, as energy, health, information technology, nanomaterials and mobility. This special support of the BMBF enables the groups of the German universities to realize their expertise in favour of these grand societal challenges at the MLZ.”

Several scientific instruments will be newly constructed or upgraded:

SAPHiR

The university of Bayreuth receives 3.5 Mio € for the upgrade of the existing high pressure press SAPHiR. It will be able to examine materials under extreme pressure and very high temperatures. Researchers will be enabled to reconstruct the conditions between inner and outer shell of the earth in depths of 440 to 660 km and thus study the atomic structure of materials under these extreme conditions.

POLI

Supported by 1 Mio €, the RWTH Aachen will put up a new polarizer for the new diffractometer POLI. The instrument will be able to polarize and focus the neutrons at the same time.

KOMPASS

The cold three axes spectrometer KOMPASS of the Universität zu Köln, which is still under construction, will receive 1.15 Mio € for a three-dimensional polarization analysis. This will allow for measuring a larger variety of magnetic and electronic structures. These structures can be the foundation for new information technologies.

PUMA

The three axes spectrometer PUMA, which is operated by the Universität Göttingen at the FRM II, will be able to even measure faster thanks to the support of 600.000 €. For the polarization analysis, both directions of polarization will be measured at the same time. This will shorten the measuring times in polarization mode significantly.

REFSANS

Researchers of the Ludwig-Maximilians-Universität München will investigate new phenomena at the interface between living animal cells and a carrier substance at the reflectometer REFSANS. The aim of the project is to examine cell adhesion and cell migration, which is moderated by an ultrathin layer, called extracellular matrix. The structure of this matrix will be examined for the first time using neutrons. They are supported by 340.000 €.

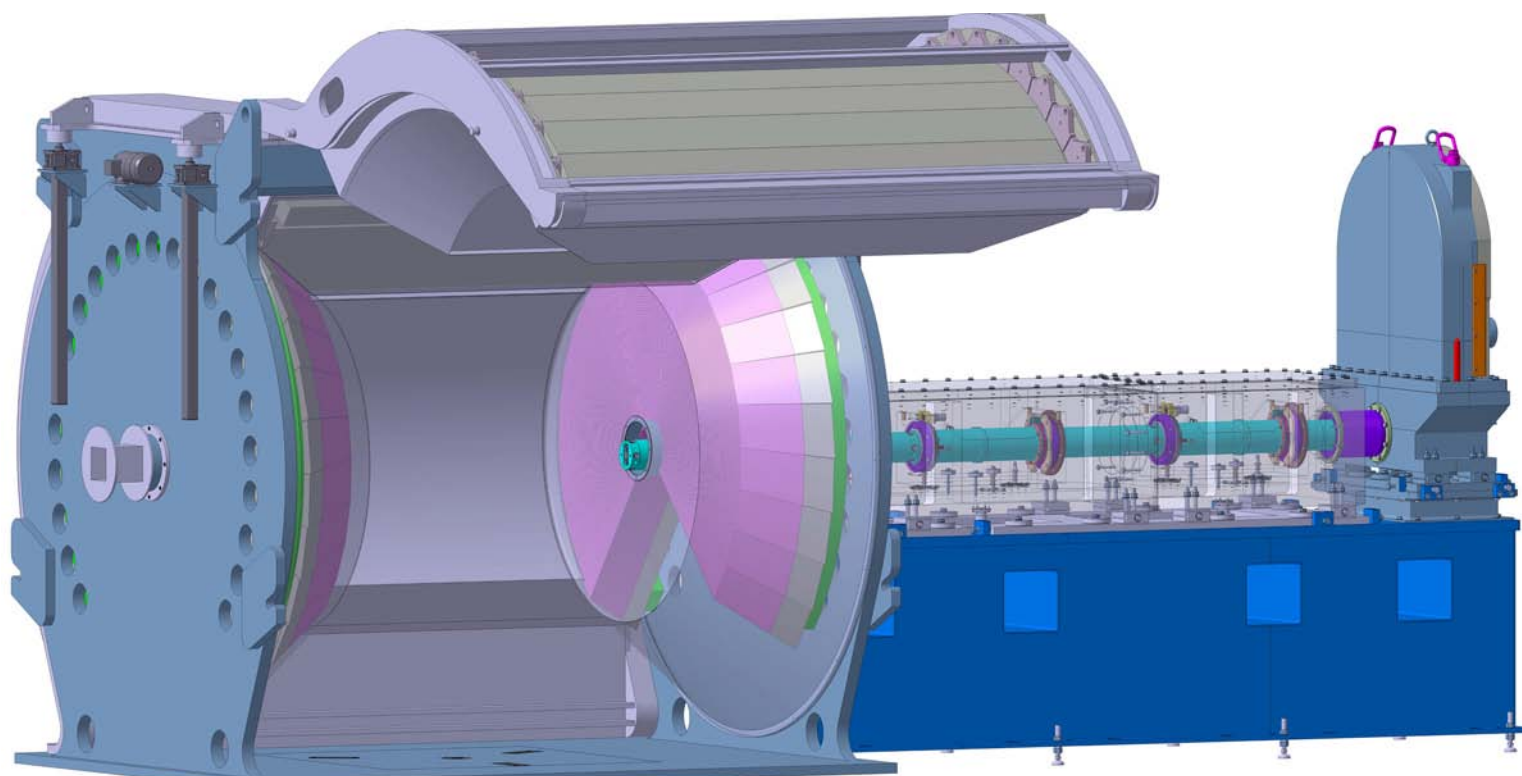
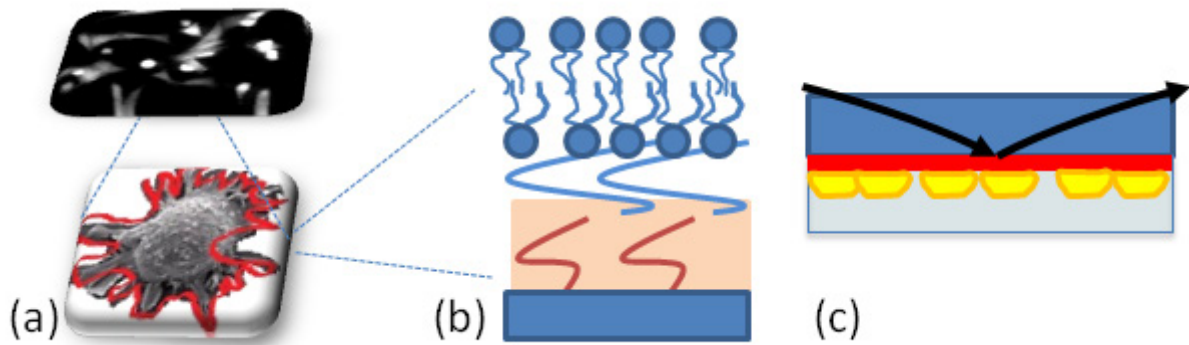

Fig. 1: The innovative ^{10}B jalousie volume-detector system (left) was tailored for the large angular coverage of the POWTEX diffractometer designed and built by RWTH Aachen University and Forschungszentrum Jülich. POWTEX is financed by means of the framework of the German Verbundforschung (BMBF). The detector itself has been developed by CDT GmbH. In fact, all components (right: highly flexible guide changer and chopper system) are customized for high-intensity powder diffraction with small samples and texture analysis.



At the instrument REFSANS, a new measuring cell will be developed to characterize biofilms at interfaces using reflectometry and small angle scattering. (a) is a schematic view of a cell ($10 \times 10 \mu\text{m}^2$). (b) shows the zoom into the cell wall, the double lipid layer and the subjacent extracellular matrix (blue). A thin interlayer (red) improves the adhesion. ($50 \times 50 \text{nm}^2$) (c) shows the measuring geometry for neutron experiments. The substrate (blue), cells (yellow) and the interlayer (red). Neutrons are symbolized by a black arrow.

PANDA

The Technische Universität Dresden will use the 140.000 € to build a flatcone multi-detector system including energy analysis for a more efficient detection of neutrons at the three-axes spectrometer PANDA.

POWTEX

The RWTH Aachen and the Geowissenschaftliche Zentrum of the Universität Göttingen will build the new diffractometers POWTEX, which will examine chemical compositions and structures of geomaterials.

ANTARES

A combined neutron and X-ray tomograph, which generates X-ray and neutron images of for example batteries or fuel cells, will be realized at the instrument ANTARES. The project of the Technische Universität München and the Albert-Ludwigs-Universität Freiburg receives a first funding of 1.2 million Euros for a high resolution neutron detector and an X-ray tube.

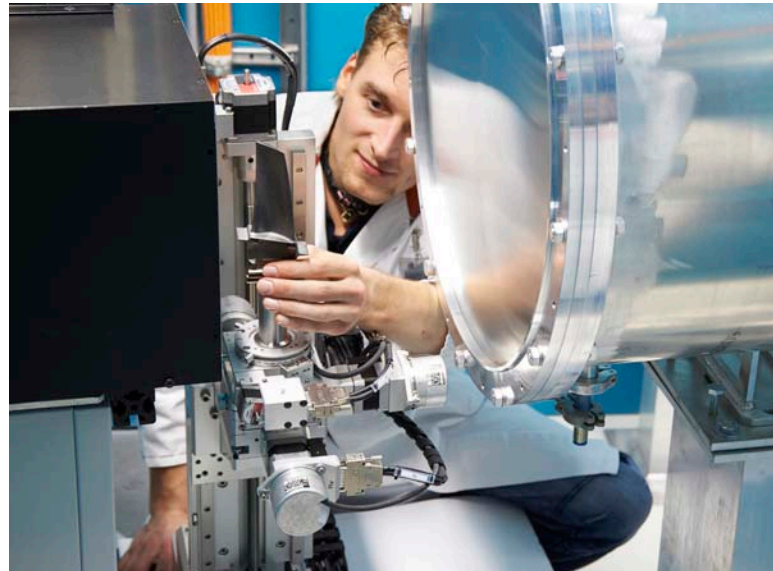

The instrument ANTARES will receive an extra X-ray tube.

Various further projects

The Forschungszentrum Jülich contributes its know-how in the construction of instruments. The 2.8 Mio € will be used for the development of sample environments, data analysis and control software.

The Universität Augsburg will produce and examine diamond mosaic crystals in order to qualify them for monochromators. The will be funded with 380.000 €. Collaborating partners are the FRM II and the ILL in Grenoble. Both, the research with neutrons and with positrons at the FRM II will be supported by the BMBF. The Universität der Bundeswehr München, the Martin-Luther-Universität Halle-Wittenberg and the TUM will construct instruments for pulsed positrons supported by 1.1 Mio €. They will be able to distinguish missing atoms in solid materials more precisely.

A. Voit (FRM II)



Working at SAPHiR.

SLOPOS13

Garching, September 15th-20th



123 delegates from 21 countries accepted the NEPOMUC research group's invitation to the 13th *International Workshop on Slow Positron Beam Techniques and Applications* SLOPOS13 and gathered at the Technische Universität München from 15th to 20th September. This event is part of a series of triennial SLOPOS-conferences. It was a great honour when the international research community chose the TUM as an organiser despite attractive competitors such as the USA, China and India.

The excellent scientific programme comprised 50 talks and 58 posters presented during two poster sessions. It was very impressive to learn about novel technical developments on positron beam facilities and the wide range of its applications all over the world. The workshop reflected the large variety of positron beam experiments covering fundamental studies, e.g., for efficient production of anti-hydrogen as well as applied research on defects in bulk materials, thin films, surfaces, and interfaces. For one of the four top-class plenary talks we could win Prof. J. Mannhart of MPI for Solid State Research in Stuttgart who gave an outstanding presentation on *Two-dimensional Electron Systems at Oxide Interfaces*.

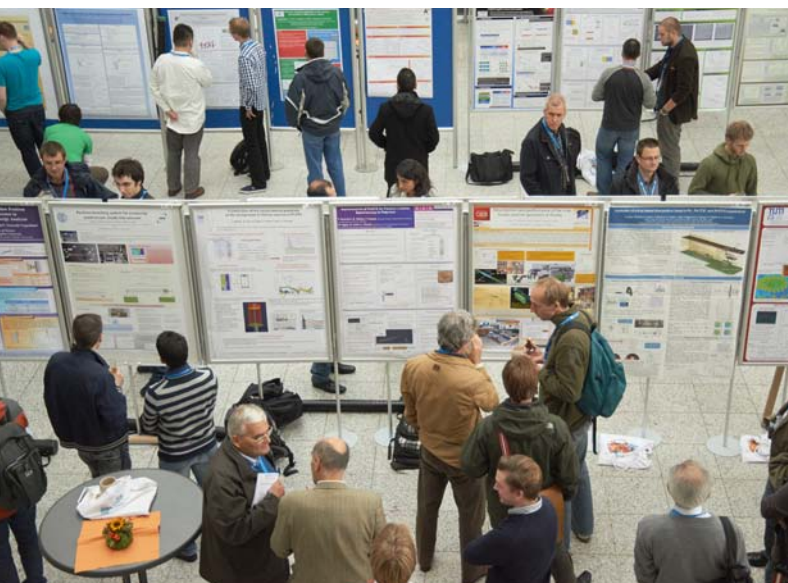

The workshop offered the unique opportunity to meet friends, get acquainted with new colleagues, and discuss lively scientific topics – also in informal atmosphere during a Bavarian Brotzeit at the poster sessions. Socializing had already started at the Welcome Reception in the Munich Town Hall on Sunday evening and was continued during the conference excursion when the delegates enjoyed the scenic surroundings of Lake Starnberg by boat. Arriving in the lovely city of Murnau, a concise introduction in history of art and an extraordinary concert for saxophone and organ in St. Nikolaus church worked up everybody's appetite for the Bavarian dinner.

The international advisory committee of SLOPOS assigned a subcommittee to award student prizes for the best presented scientific contributions. To our great delight, the prizes were given to a team of students from Finland, a French student, and the NEPOMUC team. The prizes were awarded during the Conference Banquet in one of the most famous Wirtshäuser in the heart of Munich on Thursday evening.

At the end of the conference a guided tour of the FRM II's experimental hall was offered. Particular focus was of course laid on the positron beam facility at the high-intensity positron source NEPOMUC. Hence the visitors gained an impression of the new brightness enhancement device with magnetic switches and the four different spectrometers which are currently operated:

- **Surface Spectrometer** (SuSpect),
- **Coincidence Doppler-Broadening Spectrometer** (CDBS),
- **Pulsed Low-Energy Positron System** (PLEPS), and
- a **Positronium Time-Of-Flight** experiment connected to the **Open beam Port** (OP).

The conference was overshadowed by the sudden death of Prof. Dr. Klaus Schreckenbach immediately before the workshop. In commemoration of him as a spiritual father of the neutron induced positron source a minute's silence was hold.

A very high number of conference participants already gave a pretty positive feedback that confirms the success of SLOPOS13. We are still very happy to have hosted such a fruitful workshop with its high-quality scientific contributions.

We are looking forward to SLOPOS14 in Japan in 2016!

Ch. Hugenschmidt (FRM II)



NINMACH

Garching, September 9th-12th

With NINMACH 2013 - Neutron Imaging and Neutron Methods in Archaeology and Cultural Heritage Research - the first conference worldwide was held at FRM II which explicitly dealt with the use of neutron methods in archaeology and cultural heritage.

About a hundred archaeologists, conservators and physicists from all over the world were informed about still little-known methods which allow for new examinations in their fields of work.

Special emphasis was placed on neutron activation analysis (NAA), prompt gamma activation analysis, autoradiography, and neutron computed tomography.

For autoradiography, paintings can be activated for a couple of days. Some activated atoms of the paint pigments emit gamma radiation during their decay, which can be detected with X-ray films or imaging plates. This reveals also layers of the painting that had been painted over, and sketching underneath. By energy-resolved examination of the emitted gamma radiation, the precise composition of samples can be determined, which helps to draw conclusions about the smithing techniques and alloys of Japanese helmets and swords.

Neutrons can also be used for radiography and computed tomography where X-rays fail – plant seeds can be visualized in sealed ancient pottery, bronze statues can be penetrated to visualize hollow spaces and casting cores, and fossils entirely embedded in limestone can be



examined, which hardly deliver any contrast for X-rays due to their similar composition. Even differences between enamel and dentine become visible in fossilized teeth – and allow for the discrimination between teeth of early hominids and relatives of Orang-Utan.

Besides the scientific talks, the poster session with a Bavarian “Brotzeit”, and the possibility to either tour the FRM II, the Neue Pinakothek or take part in a workshop at the Bavarian National Museum Restoration, the participants were especially delighted about the welcome hike to the Herzogstand, a famous Bavarian mountain with a really breathtaking outlook. The conference dinner at the State Brewery of Weihenstephan (said to be the World’s oldest brewery) went down well, too!

The next NINMACH will be held again in Garching in spring 2015, and will be followed by a conference at the Budapest Neutron Centre in Hungary in 2017.

B. Schillinger (FRM II)

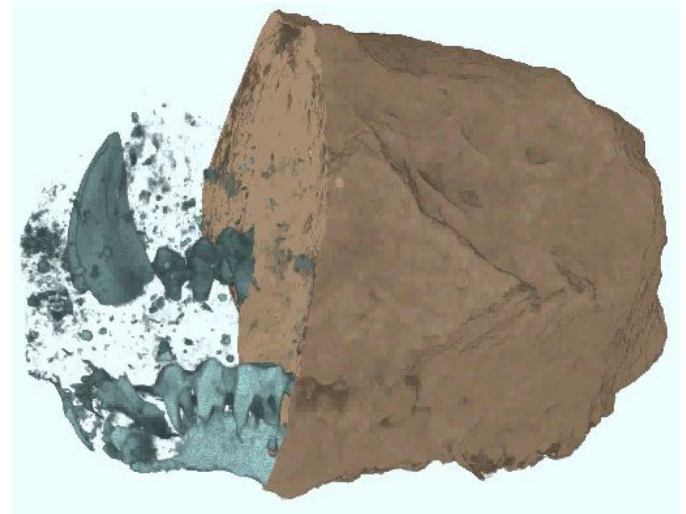
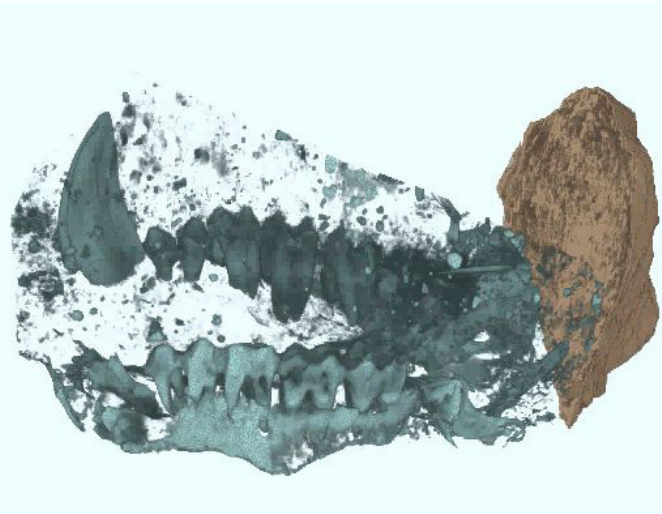

An upper jaw entirely embedded in a block of limestone found in South Africa, possible of an ape, like a baboon. In the neutron tomography data-set, the surrounding limestone is set to invisible so the jaw bones and teeth become visible, along with several pebbles.

JCNS Workshop on Magnetism and Correlated Electron Systems

Tutzing, October 7th-10th



Seventy key experts and specialists from Europe, USA, Canada and Japan took part in this event, which involved a total of forty invited and contributed presentations and twenty posters as part of the workshop's programme.

The charming location of the Evangelische Akademie in Tutzing, together with the enthusiasm of the highly-motivated attendees, created a stimulating atmosphere which resulted in numerous discussions throughout. The topical sessions were chosen to span an extremely wide area covering *Magnetic Nanoparticles and Nanocrystals*, *Molecular Magnets*, *Unconventional Superconductors*, *Magnetoelectrics and Multiferroics*, *Frustrated and Complex Spin Systems*, *Interface Effects in Heterostructures*, and *Materials for Energy Conversion and Storage*.

Excellent quality grown artificial multilayers of superconducting and magnetic materials form the basis for the study of fascinating nanoscale effects in the layers and at interfaces. In this field, neutron scattering and reflectometry is of fundamental importance for the under-

standing of the key processes. Furthermore, polarization analysis opens a new route to the understanding of the exotic ordering phenomena in frustrated spin systems. Magnetic nanoparticles are investigated for applications in magnetic data storage and medicine. Method development in neutron scattering now allows the study of the dynamics of these particles in solution on ever shorter timescales, in terms of the magnetic structure of single particles and nanoparticles assemblies as well as magnetic excitations.

Thermoelectric materials for energy harvesting in waste recovery systems have found applications in niche markets. More efficient materials are urgently needed to widen the application of these devices. Inelastic scattering turns out to be an efficient tool to understand the mechanism of the low thermal conductivity in these materials. The rapid progress in the research of nanomagnetism and correlated electron effects in a variety of different materials has resulted in an ever increasing challenge to extend the limits of existing neutron instrumentation. The JCNS instrument suites at leading neutron sources are capable of meeting the most demanding of future requirements, with the planned up-grades and new instruments shortly to be introduced.

JCNS contributed in total twelve oral presentations and 13 posters, underlining the key role of JCNS in neutron scattering based research in magnetism, superconductors, thin film heterostructures, and advanced instrumentation.

The next JCNS workshop will again be held in Tutzing from October 6th to 9th, 2014.

R. Bruchhaus (JCNS)

17th JCNS Laboratory Course Neutron Scattering

Jülich and Garching, September 2nd-13th

As in previous years, this annual lab course was held at two locations: Forschungszentrum Jülich for the lectures and the FRM II in Garching for the experiments.

The lab course is open to students world-wide of physics, chemistry, and other natural sciences. Participation is free of charge for the selected students, and travel expenses are reimbursed for foreign students. The course is part of the curricula of the Universities of Aachen and Münster. Financing came from Forschungszentrum Jülich with support from the *Integrated Infrastructure Initiative for Neutron Scattering and Muon Spectroscopy* (NMI3), the *European Soft Matter Infrastructure* project (ESMI), and the European Network of Excellence *Soft-Comp*.

The first week of the neutron scattering course is always dedicated to lectures and exercises encompassing an introduction to neutron sources and presenting scattering theory and instrumentation. Furthermore, selected topics of condensed matter research were addressed.

In the second week, eleven instruments at the FRM II are made available for students' training, including the neutron spin-echo spectrometer J-NSE, the backscattering spectrometer SPHERES and the small-angle scattering instruments KWS-1 and KWS-2. These world-class instruments were provided by JCNS, RWTH Aachen, Universität Darmstadt, Universität Göttingen, LMU, and TUM

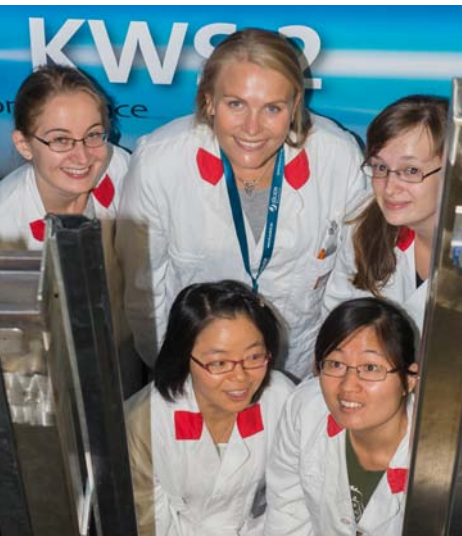

This year 57 students were selected from 147 applicants. The majority of the students were from Physics (31) followed by Chemistry (24), and Biological Sciences (2). 20 foreign students came from a total of 11 countries. For the second time students from Palestine were participating in the course. Five students from St. Petersburg State Univer-

sity participated because of a cooperation with PNPI, Gatchina. The number of female students had (42%) slightly increased compared to the years before.

The programme was completed by a welcome party in Jülich and a farewell party in Garching. For the latter, a students' café was opened in the evening allowing the students, tutors and organizing staff to relax with food, drinks and dance.

The next JCNS laboratory course will take place from September 1st to 12th, 2014. You are cordially invited to submit applications. In January 2014 more details will be posted at www.neutronlab.de.

Reiner Zorn (JCNS Jülich)

Single Crystal Spectroscopy: Multi-TAS or ToF?

Murnau, October 10th-11th

32 scientists from Europe and Japan attended the scientific workshop organized by the Jülich Centre for Neutron Science (JCNS) of Forschungszentrum Jülich. During the night, winter's silent arrival brought with it heavy snowfall, resulting in streets and train tracks blocked with snow. However, this unexpected event did not inhibit the lively discussions centred on the workshop's fourteen oral presentations.

Three axes spectrometers (TAS) are recognized by scientists as the instruments of choice for single crystal spectroscopy, a non-destructive analytical technique providing detailed information about atomic motions within crystal lattices. Continuous improvements and upgrades using modern neutron optics and technology ensure that these instruments are always maintained to the latest technical standards. With recent upgrades, at several of the three axes spectrometers optional multiplexing secondary spectrometers have also been developed or installed. These allow the acquisition of more information in a single scan; as a result, measurements are expected to be made faster and more efficiently. In addition, the time-of-flight (TOF) technique is a significant improvement on single crystal spectroscopy and has become a powerful complement - or alternative - to TAS spectroscopy.

During the workshop, presentations from three axes instrument scientists on multiplexing options and from TOF spectrometer scientists from reactor as well as spallation sources gave an overview of all options, both existing and planned. Attendees had the opportunity to explain their wishes and needs, and shared their experiences from the user's point of view.

In this way, it became clear that the multiplexing option can turn into a rather complex set-up compared to standard TAS or TOF techniques. To cite from the title of one of the talks, for the instrument scientist, it is important to "trade efficiency against complexity" and eventually even to focus on certain modes of operation. User-friendliness is one of the crucial aspects to be tackled. The software currently available for planning an experiment and evaluating and visualizing the data is incomprehensible and more time-consuming than for standard TAS. Users must be informed about how to choose the most effective strategy for their experiments.

The workshop was rounded off by an excursion to the Mürter-Haus, the home of the expressionist painters Wassily Kandinsky and Gabriele Münter and their many guests from 1909 – 1914.

Our sincere thanks go to all attendees for the stimulating and pleasant atmosphere!

A. Schneidewind (JCNS)



Open House at the FRM II

Garching, October 19th



The Pied Piper of the FRM II: Technical Director Anton Kastenmüller starting his tour for children.

Bright sunshine attracted on this warm Saturday in October crowds of interested visitors to the research campus in Garching as every year. And as every year, the line for the registration for a tour of the FRM II in front of the desk was long and all tours were fully booked at 13:30. This year 484 visitors in total took part in the guided tours of the neutron source.

New was the strategically positioned information booth with the Lego models of a three axes spectrometer and a time-of-flight spectrometer beside a monitor in the Physics Department of the TUM. While the visitors were

queuing they could shorten the waiting time watching movies of the FRM II on the monitor, for example about the replacement of the fuel rod. Also new were three information boards that they could read without any hurry while queuing, information was also displayed and widely used. The moving Lego models attracted many visitors throughout the day, who wanted to learn about neutrons, the instruments, and the research. They asked questions that were very detailed demonstrating how much they were interested in the matter: “What kind of material is used for a collimator? How does the detector work? What exactly does it measure? What can you study with it? Do the images look like X-rays images?” Most of them were very responsive and impressed. Many visitors return year after year to the open day and like to take the opportunity to learn more about the latest research and methods. Thus the lectures about the MLZ and the FRM II in the lecture hall were without exception well attended, topics such as *hydrogen storage* went down well. Even the younger visitors who were too young for the guided tour, found something exciting: They could target with “neutrons” at the “atoms” of a crystal lattice and try to hit them. Who hit at least three “atoms” with his four “neutrons”, had thus won a T-shirt with the logo MLZ.

Ch. Kortenbruck (FRM II)

Highlights der Physik

Wuppertal, September 16th-21st

The FRM II press office was part of the *Highlights der Physik* exhibition in Wuppertal, representing FRM II and MLZ at a stand. The location was right in front of the city hall of Wuppertal in the middle of the pedestrian shopping zone. According to the location, the visitors were quite diverse. In the mornings, school classes crowded the tents, in the afternoons and on the weekend, the fascinated pupils came back with their parents. Even

a neo-nazi demonstration right next to the tents on Saturday and a resulting police block of the shopping zone could not stop the population of Wuppertal to visit the exhibition. More than 30 other institutions exhibited their experiments

next to us. Thanks

to the tireless preparations of Connie Hesse, two Lego models of MLZ instruments were the admired centre of the stand. The moving and blinking roboters attracted children as well as grown-ups, who wanted to learn more about *uncharged particles* (the theme of the stand). A screen presenting films about the fuel element and several instruments as well as brochures and flyers completed the stand. At a neutron ball toss, children could throw “neutron” balls at five “atoms” and try to hit them in order to win a MLZ T-shirt. In the end, 150 T-shirts had changed hands. And we are sure: Some of the children will have absorbed bits of information about neutrons and their applications!

Highlights der Physik was first created in 2000 by the Federal Ministry of Education and Research (BMBF) and the **Deutsche Physikalische Gesellschaft (DPG)**. Since then, the exhibition tours across Germany changing the focus every year. This year’s motto was *From the Big Bang to the Universe*.

A. Voit (FRM II)



Christine Kortenbruck in front of the neutron ball toss.

Internal Science Meeting

Grainau, June 10th-13th



After five meetings in the Burg Rothenfels there was a decision to enlarge our biennial internal meeting and change the venue to another place due to the newly founded MLZ with many more colleagues than ever before. The decision was finally made in favour of the Jungbauernschule Grainau. More than 90 participants were counted after the mayor part arrived directly by bus from the gate of FRM II. The new venue provided a high standard of rooms, and only a few people had to be swapped out to nearby hotels. Especially the scenery of the Zugspitze supported a really congenial atmosphere. The scientific part of the meeting provided eight plenary

overview lectures from the five topics of the newly founded scientific groups: *Soft Matter*, *Material Science*, *Quantum Phenomena*, *Structure*, and *Methods*. The science groups separated for three parallel sessions where scientific contributions were discussed in more detail. An interesting evening talk was given by Peter Fierlinger about connections between high energy physics and astronomy. Some students who could not be included in the lecture programme were given the chance to contribute to the poster session.

Since exchange and networking was the main focus of the meeting, two hiking tours were offered. One took us from Grainau to the Eibsee. Especially the view from the Eibsee to the surrounding mountains was overwhelming. The second tour took us to the Höllentalklamm, a narrow and humid gorge with outrageous impressions about the force of nature. Throughout the two hikes the whole group was dynamically mixed and so everybody made some new acquaintances. The social highlight was taking place after the Eibsee tour when all participants convened at the restaurant *Eibsee-Pavillion*. Here, a dinner was prepared directly from the grill.

The feedback afterwards was completely positive and we are looking forward to our next meeting!

H. Frielinghaus (JCNS)

TUC-MLZ Texture School@ FRM II

Garching, October 15th-17th

Following the long tradition of the Clausthal University of Technology (TUC) organizing texture schools from early '70s, the 2013 issue was held at the MLZ. From the beginning of the FRM II project, TUC was active taking part in the construction of a materials science diffractometer at the neutron source (STRESS-SPEC) and implementing crystallographic texture research. Beside instrumentation like the worldwide unique robot system for automatic texture research, teaching is a key topic to bring new customers to texture analytics.

The topic of the texture school *From Area Detector to Pole figures*, organized by Heinz-Günter Brokmeier (TUC), was directly connected to modern instrumentation for neutron, synchrotron and lab-X-ray experiments. 22 participants from different universities, research institutes, and industry were welcomed by the local organisers Michael Hofmann (FRM II, TUM) and Weimin Gan (HZG).

The school programme comprised introductions in crystallographic textures, pole figures and orientation distribution functions (ODFs). A key point was the practice of data treatment from area detector images to pole figures using corresponding software packages. The

importance of proper sample preparation and choice of measurement technology were highlighted using actual examples of texture measurements.

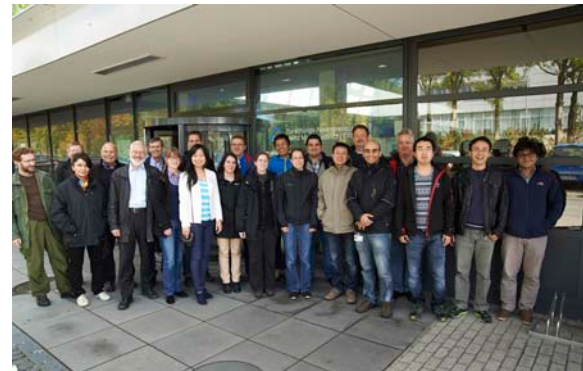

The course was rounded off by tutorials which included extraction and analysis of pole figures from recent measurements on STRESS-SPEC (neutrons) or HEMS (synchrotron, HZG); and the interpretation of ODFs gave everybody a deeper insight in the importance of texture analysis in materials science.

Finally, all the participants took the opportunity to visit the experimental halls of FRM II, which gave them a good impression on the broad range of applications of neutron scattering in materials science.

W.M. Gan (HZG)

Design and Engineering of Neutron Instruments Meeting (DENIM)

Oak Ridge, October 8th-9th



Established in 2012, the *Design and Engineering of Neutron Instruments Meeting (DENIM)* was held at Oak Ridge National Laboratory (USA) for the second time. Several engineers of the MLZ used the opportunity to exchange ideas with colleagues from other facilities. They actively participated in discussions and talks about experiences and challenges in the fields of techniques for constructing and upgrading instruments as well as the necessary infrastructure. Fruitful discussions aimed at the analysis and the amelioration of those techniques and all organizational structures. The increasing number of instruments and their growing complexity as well as the more complex sample environment and infrastructure

demand further development in organisation and project management. A promising optimisation approach was discussed: Based on more detailed and precise specifications of the researchers, the design, engineering and project management of the engineers could result in higher quality, more efficient exploitation and adherence to schedules. At the same time this would offer more freedom for the researchers' scientific work. This would also have synergies in better exploiting the financial funds and engineers' resources for the benefit of the research.

The organizers at the Oak Ridge National Laboratory managed to create an open atmosphere for a really useful and interesting meeting. A visit of the spallation source and the neutron source beside the detailed interchange of ideas about working with specifications and their structuring completed the programme. Now, the participants plan to establish a new community for design and development of neutron instruments and infrastructure to stay in touch between the meetings and use the newly-won synergy.

Good news for the MLZ: The next DENIM 2014 will take place in Garching on September 16th-18th!

U. Reinecke (FRM II)

International Conference on Neutron Scattering (ICNS)

Edinburgh, July 8th-12th

The Scottish are said to be mean. During the week of the ICNS, the neutron scattering community learned, that they are definitively not mean regarding sunshine, high temperatures, well organised conference centres and last but not least wonderful locations for social events. It starts with the welcome reception at Our Dynamic Earth, an exhibition presenting our planet's story: Thanks to the really hot weather everyone was especially interest-



ed in the part dealing with polar extremes. Wednesday saw the participants conquering Edinburgh Castle. The amazing outlook to the beautiful city as well as the offer to visit the Scottish Crown Jewels will hard to be topped in the future! On Friday evening, the conference dinner took place in a Victorian hall of the National Museum of Scotland and was closed by a Céilidh dance.

Besides all these events, 800 scientists from 34 countries presented and discussed their scientific work in talks and posters. Many of them paid also a visit to the more than 50 exhibitors: Facilities, projects, and companies presented themselves in Edinburgh. The MLZ shared the biggest booth with the Helmholtz-Zentrum Berlin and welcomed many interested visitors. Flavio Carsughi and Ina Lommatzsch of the MLZ User Office and Heike Gast of the HZB User Office were happy to meet well known users as well as all new ones and those who will be users in the future!

On Thursday, most of our colleagues came together and posed for the obligatory group photo of MLZ and HZB. This was a really serious session as you can see...

I. Lommatzsch (FRM II)

ESS@MLZ

Technology for a brilliant future of neutron scattering

In 2019, the **European Spallation Source (ESS)**, a joint project of 17 European countries, will start operations, initially with seven instruments. It will generate the world's most intensive neutron pulses and permit gaining unique insights into matter for basic as well as application-oriented research. The construction is expected to start soon, and plans call for the number of instruments to be increased to 22 by 2025.

Since November 2010, seven research institutes in Germany contribute to the design-update phase of the ESS within a German collaborative project, supported by the Federal Ministry of Education and Research (BMBF). Next to the Helmholtz Centres Forschungszentrum Jülich, Berlin (HZB), Geesthacht (HZG), Dresden-Rossendorf (HZDR) and Desy, the Karlsruhe Institute of Technology (KIT) and the Technische Universität München (TUM) are engaged in the design of novel components for the accelerator, target, instrumentation and critical instrument components. The project management is located in Jülich. With altogether 22 work packages Germany is the strongest partner of the ESS.

ESS will provide worldwide unique possibilities for research with neutrons and will have flagship capability. As a result of the conceptual design work during the last years a number of instrument concepts emerged that will meet the coming scientific needs. To do this well they are optimised to best utilise the beam characteristics of the ESS long pulse source. Depending on the type of instrument the utilisation of neutrons is enhanced beyond the average flux by taking advantage of the 25 times higher peak flux during the 3 ms pulse or by using the large wavelength frame width arriving during the 70 ms between subsequent pulses or by a combination of both.

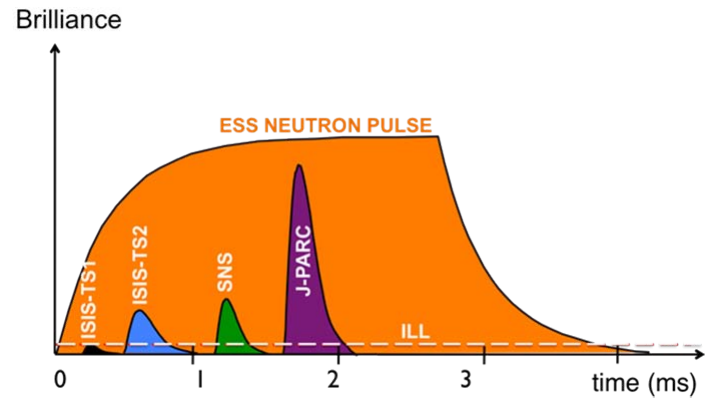

Fig. 1: Neutron brightness of the ESS moderator compared to that from other sources.

Small angle scattering, reflectometry and spin-echo instruments benefit from the available wavelength frame bandwidth between pulses while the time-of-flight and diffraction instruments rely on the high peak flux and on repetition-rate or frame multiplication. Thus information carrying scattered neutrons arrive at the detector during the complete time interval between two source pulses. By these measures and optimised layout of the beam transport from moderator to sample and efficient detection the envisaged new instruments will have gain factors between one and two orders of magnitude compared to others. Starting with the high source brightness this is achieved by taking advantage of the modern capabilities to realise neutron guides with high m-coatings and elliptic or parabolic geometry and innovative chopper concepts. In general, for the best performance at the novel type of a very high intensity long pulse neutron source,

suitable and optimised special components are needed that must undergo a coevolution with the instruments. Next to the above mentioned neutron guides and choppers the most prominent among them are detectors, polarisers (^3He) and ESS specific sample environment.

E.g. each new ESS instrument will have 4 to 6 (or more) choppers, ranging from heavy T0-choppers that block the intense prompt pulse over more conventional frame overlap disc choppers to fast rotating choppers possibly with sophisticated pulse sequences. Detectors have to

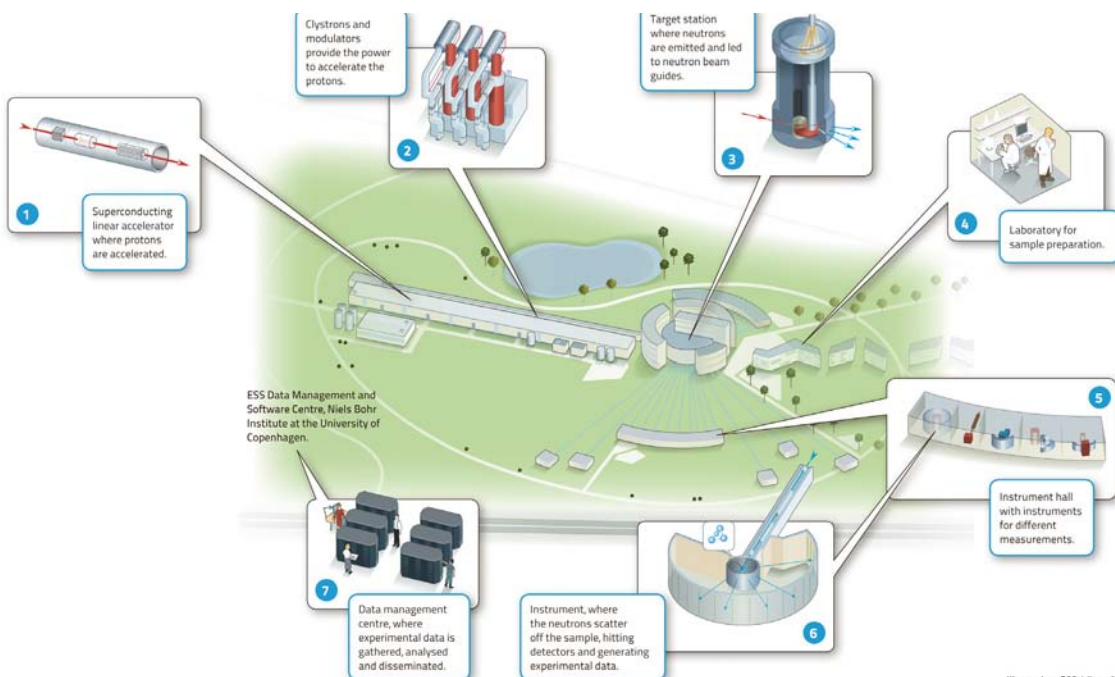

Fig. 2: How the ESS works.

Illustration: ESS, Lönnegård

Layout of the instrument:

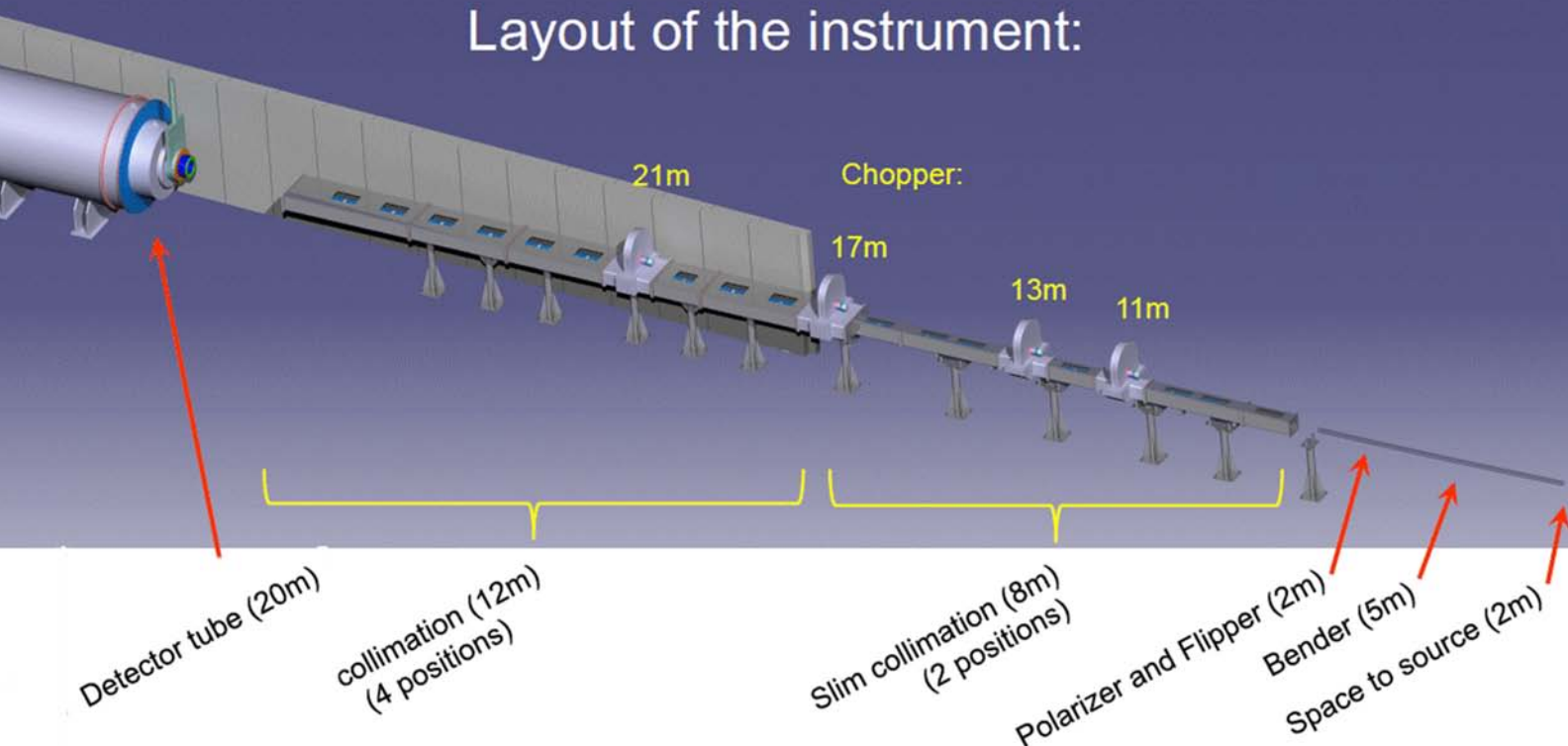

Fig. 3: Layout of SKADI. All lengths and positions (yellow) are given in m. The drawing is to scale, but the full length of the detector tube extends beyond the picture boundary.

cope with increased intensity and count rates while at the same time supplying high detection efficiency and spatial resolution. The needed detector areas range from 0.1 m² up to ~40 m² depending on the instrument. The huge total demand for detectors coincides with a current (and probably future) shortage of ³He, which until recently was widely used for efficient neutron detection. In particular the latter situation triggered alternative detector developments without ³He, which rather rely on scintillation (⁶Li) or thin film boron (¹⁰B) gas detectors.

Polarization is becoming an integral asset of most new neutron instruments and for ESS methods are needed for efficient neutron polarisation over large solid angles and wide wavelength ranges. Polarised ³He is a promising perspective for many applications, in particular if short wavelength neutrons with large solid angles shall be covered.

All critical instrument components are treated in the German ESS design-update project.

As an outcome of the extensive work in the last three years, Forschungszentrum Jülich, TUM, and HZG submitted altogether seven proposals for first class instruments at ESS in 2013.

At the Heinz Maier-Leibnitz Zentrum, working on

- a small angle scattering instrument,
- a vertical reflectometer and
- a time-of-flight instrument

resulted in instrument proposals that were submitted to the current round. The LLB (France) is an international partner for those proposals. Moreover, efforts at the MLZ

have been focussed on ³He polarization techniques and novel detectors.

Let's have a closer look at the MLZ activities for the ESS!

SANS: SKADI instrument

H. Frielinghaus (JCNS@MLZ)

In recent years, a progressive increase in the use of small-angle neutron scattering experiments for the investigation of biological and medical samples as well as soft matter samples in general has occurred. Also magnetic or hard matter samples and samples for energy research, such as on fuel cells, have received increasing attention. Higher fluxes gave the possibility for very detailed structural characterisations. In interaction with highly improved instrument availability and data evaluation methods this made SANS indispensable in a wide variety of scientific fields.

A major leap in terms of neutron flux will further enhance the usability and versatility of neutron scattering experiments. The proposed **S**mall **K** Advanced **D**iffractometer (SKADI) at ESS will outperform any of the presently available SANS instruments in terms of flux. Furthermore polarization will allow for the analysis of magnetic scattering and separation of coherent and incoherent intensity contributions. The extended q -range from $1 \cdot 10^{-3} \text{ \AA}^{-1}$ to 2 \AA^{-1} makes it possible to gather information over a wide range in a single-shot measurement, which is advantageous, among other things, in kinetic experiments. It also will close the gap between conventional SANS measurements and other diffraction instruments, mak-

ing the intermediate size regime of molecular ordering accessible. It will be possible to address structures of the size between sub-nanometers and micrometers with only one experiment setting.

The guiding idea when designing SKADI was to create an instrument, which shows excellent performance in terms of flux, q -range and resolution while maintaining the possibility to use classical SANS sample sizes of up to $1 \times 1 \text{ cm}^2$. This allows for high scattering intensities at still well defined sample conditions, such as pressure or temperature, even on short time scales as needed in kinetic experiments. The expected scattering intensity will allow time slices on the order of some tens of microseconds with a still sufficient intensity.

The layout of SKADI is illustrated in fig. 3. It will have a collimation length of 20 m along with a detector tube of 20 m. Inside the detector tube there will be two detectors, which will simultaneously record scattering in the high and low q -regime. The unique features of SKADI will be:

- Highest possible intensities available at ESS for fast acquisition and kinetics or for the investigation of very small or dilute samples.
 - Neutron polarization for magnetic studies and incoherent background separation.
 - Wide simultaneous q -range of three orders of magnitude enables acquisition of complete “one-shot” kinetics data.
 - q -range extendible by VSANS option down to several 10^{-5} \AA^{-1} .
 - Extended spatial range into the micrometers domain by a SESANS option.
 - Large space around the sample position (up to more than 3 m in length) for custom sample environments.
- Large effective intensity gains compared to the best present instruments are expected. Comparing the scattering of water for SKADI and D22 using wavelength bands of 2 to 9.2 \AA and 4 to 11.2 \AA gain factors of 33 (up to 40) are found.

Vertical Sample Reflectometer

S. Mattauich (JCNS@MLZ)

The ESS will provide an exciting opportunity to design a reflectometer of the next generation to meet the increasing demand and anticipated scientific challenges. The anticipated research topics comprise a wide range of scientific disciplines, ranging from thin film magnetism and novel topological phases in confined geometries, over the functionality and properties of hybrid materials in the field of soft and hard matter to the structural biology of membrane proteins.

The proposed instrumental concept is focussed on designing a machine that is dedicated to the major tasks pertaining the expected research topics. I.e. a reflectometer with high intensity at the lowest possible background meets the challenges posed by investigating thin layers or interfacial areas in the sub-nanometer regime. The high intensity approach of the vertical reflectometer fits very well to the long pulse structure of the ESS. For a full picture one requires unpolarised and polarised specular reflectivity for probing the thin layers and off-specular scattering (μm sized lateral structures) as well as the GISANS option (for nm structures) to investigate the lateral structures of the sample. These key features are optimised for the proposed instrument to deliver the maximum possible performance. Any additional features such as the high resolution mode and additional focusing options shall not compromise the above optimisation.

The proposed instrument (fig. 4) is primarily designed for the investigations of thin interfaces from several nm down to the sub nm range. Its main goal is therefore to deliver as much usable intensity as possible to the sample position being able to access a reflectivity range of 8 orders of magnitude or more. To achieve this goal the neutron beam will be transported to the sample using an optimised elliptic neutron guide providing the focussing in vertical plane without spoiling the Q-resolution in the horizontal plane. The choice of instrument length of 36 m

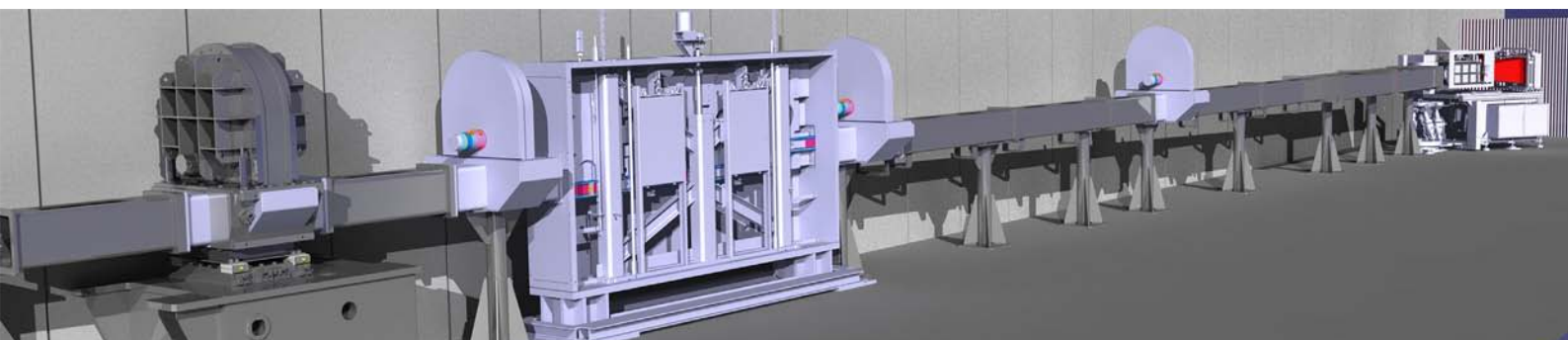

Fig. 4: Impression of the reflectometer outline showing the elliptic guide section with chopper 1 (left) and polarizer changing section ending with the sample and detector stages (right).

allows achieving the resolution of 10% for the maximal use of neutrons emitted within the ESS pulse. The integrated intensity over the full wavelength band delivered to the sample amounts to $3.0 \cdot 10^9$ n/cm² for each single pulse of the ESS (that corresponds to $4.2 \cdot 10^{10}$ n/cm²/s) and is about 25 times higher than one can achieve at D17 reflectometer at the ILL, thus allowing to measure reflectivity up to 10^{-9} within minutes.

The instrument will be furthermore capable to work in specialised operational modes. This will broaden the capabilities of the instrumental concept towards a highly focused beam to 3×3 mm² or even less and a higher wavelength resolution down to 1%. The highly focussed beam will allow to investigate very small samples that consist of more complex compositions (e.g. laterally ordered structures, arrangements of molecular magnets, etc.) or materials which are in general difficult to be produced in large amounts. The wavelength resolution of the proposed instrument can be tuned by using an additional pulse shaping chopper allowing for a wavelength resolution down to 1% which is needed for the investigations of thicker layers with thicknesses of up to 1000 Å. In the GISANS mode the vertical focussing is disabled, so that a perfect collimation base for a fixed collimation length of 4m will be formed, where the resolution can be adopted to the needed values in the vertical and horizontal direction. The integrated intensity over the full wavelength band will amount to $1.8 \cdot 10^8$ n/pulse/cm² (that corresponds to $2.5 \cdot 10^9$ c/s/cm²).

The polarization of the neutron beam will be provided by a Z-kink super mirror configuration, allowing a very effective polarization for the whole wavelength band. For purposes of the polarization analysis either transmission solid state polarisers (particularly for specular reflectometry mode) or ³He neutron spin filters (for off-specular reflectivity and GISANS modes) will be used. The latter will be based upon on-beam optically pumped large SEOP cells providing constant and high polarization efficiency over the whole size of a large position-sensitive detector. The polarization analysis will be not only essential for magnetic studies with the reflectometer, but will also help to dramatically reduce the level of incoherent background of hydrogen containing soft matter samples by two orders of magnitude.

C-SPEC – the cold direct chopper spectrometer

W. Lohstroh (TUM@MLZ)

Many research fields and scientific questions of the future can best be addressed using a high performance direct geometry time-of-flight spectrometer. The areas of interest include biological and life sciences, soft condensed matter research, materials science and materials development, or novel magnetic phenomena. The questions to be addressed are driven by fundamental interest as well as technological relevance. Common to these

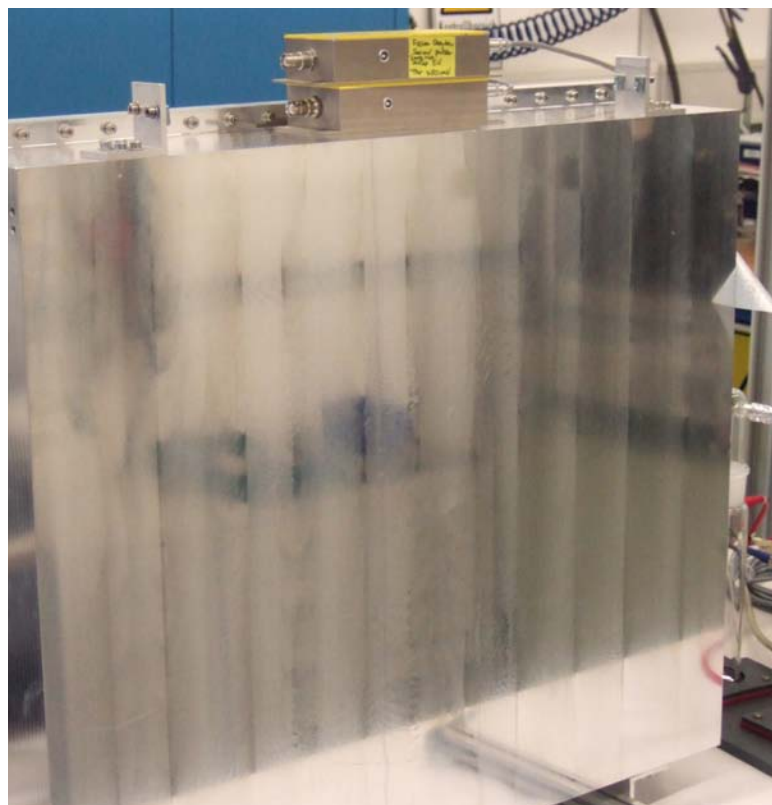

Fig. 5: Prototype detector for testing.

seemingly diverse areas is the fact that the full understanding of their properties and functionalities requires a detailed understanding of their dynamics. Most prominently in biology: Life depends on mobile water and with ceasing mobility of the water molecules all biological activity comes to a halt. Similarly, dynamic properties govern the response of stimuli responsive polymers, hydrogels, or of molecular liquids. Ideally, these materials will be studied while the external stimulus is applied (e.g. pressure, electrical potential or similar) in dedicated pump-probe experiments. On the other hand, measurements of the excitation spectrum of novel magnetic materials are crucial for the understanding of the interaction potentials and to benchmark experiments with theory. Those questions will be relevant in the coming years and the quest to answer them drives the development of the time-of-flight chopper spectrometer proposed by TUM in collaboration with the LLB (France).

The science drivers that are briefly summarised above require experiments in the time domain ranging from pico- to nanoseconds. For that, the instrument is designed to cover an energy resolution of $\Delta E/E = 6 - 1\%$ and it will utilise cold neutrons in the range from $\lambda = 1 - 20$ Å. Most experiments are expected to require settings of about 3% energy resolution (i.e. 100 µeV at $\lambda = 5$ Å) and the instrument performance is optimised for these values. For these settings, the optimum instrument length is found to be 120.4 m which permits a wavelength band of 2.5 Å at the detector position. The operation parameters of the chopper system enable the choice between single

and multi energy mode, and the number simultaneously probed incoming energies E_i can be chosen according to the requirements of the experiment. In general, approximately one order of magnitude of ΔE can be probed simultaneously in any experiment. The guide systems will have two configurations, i.e. a large homogeneous beam spot and a focussing option. It will be realised by an exchangeable guide section after the monochromatizing system. In this manner, the different requirements of the science drivers can be accommodated: Hydrogenous materials and singles crystals benefit from a larger beam spot with homogenous flux distribution and low divergence while experiments with restricted sample sizes (either due to a limited amount of sample, or due to the sample environment restricting the access) are best investigated using a focussed beam. The secondary spectrometer will have a flight path of 4 m and an angular coverage of $-15 - 140^\circ$. The detector will be based on ^{10}B , supposed the maturity of the ^{10}B converter layer detectors is sufficiently advanced. A reasonable side access of the sample area (of approximately 60°) is favoured over larger angular detector coverage as it facilitates the integration of more specialised sample equipment and secondary characterisation of the samples online. We expect an increasing demand of these kind of experiments in the coming years as there is a trend to investigate increasingly more complex samples which are technologically more relevant. With these specifications, the instrument will serve a broad user community, and significant advances in the field of biology, soft condensed matter, materials science and magnetic phenomena can be expected from day one of instrument operation.

Development of novel detectors

K. Zeitelhack (TUM@MLZ)

In view of the ebbing supply of ^3He the development of technologies for neutron detection alternative to ^3He based detectors is of vital interest for the ESS. In addition, the intense pulsed neutron beams at ESS put severe constraints to the design of new detectors due to the high count rate capability and large active area required for most of the instruments.

Within the framework of this development for ESS different approaches are pursued in four work packages studying different technologies like ^6Li -doped scintillation detectors and solid neutron converters in gaseous detectors.

The potential use of solid ^{10}B converters in gaseous detectors is the main topic of the third work package, which is treated at MLZ. The performance of a "macro structured" converter surface in a multilayer arrangement is studied in a $40 \times 40 \text{ cm}^2$ prototype detector (see fig. 5). The production of optimised B_4C layers by sputtering methods and their use in a prototype detector with inclined converter geometry is investigated at HZG.

^3He Polarization Technique

A. Ioffe (JCNS@MLZ)

Polarization analysis is a powerful tool for the analysis of complex magnetic structures and the study of magnetic excitations as well as the separation of nuclear spin-incoherent background. Its use in neutron scattering is becoming increasingly important and it is foreseeable that this will particularly apply to the new instruments at the ESS. The polarisers/ analyzers that will be used at the ESS should work in a broad wavelength range, being effective already at short wavelengths, of about 1 \AA . Moreover, the use of large detector arrays that is envisaged for most of the ESS instruments requires that the analysers cover a wide solid angle and accept highly divergent neutron beams.

To achieve this goal, a new type of a wide-angle ^3He analyser is developed. It is based on the so-called PAS-TIS setup (that is to place the ^3He cell in a set of orthogonal Helmholtz coils that can create a homogeneous magnetic field in an arbitrary direction). This design has been further developed introducing μ -metal sheets to produce a magnetic field with improved homogeneity in a large region and to reduce the blind area due to the support material of the Helmholtz coils.



Fig. 6: Doughnut shaped ^3He polarisation cell ($\varnothing 20 \text{ cm} \times 8 \text{ cm}$).

Besides the magnetic system, a ^3He cell covering a wide solid angle is the second crucial element of such a setup. A method for manufacturing of GE180 doughnut like cells (see fig. 6) was developed in the FZ Jülich glass workshop. This cell placed around a sample in a cryostat will allow for large angle polarization analysis. Being the first such cell in the world with an outer diameter of about 20 cm, it provides a life time of the polarised ^3He of about 680 hours.

A. Wischnewski, M. Monkenbusch (FZ Jülich)

Unveiling the Past

Neutrons for archeology

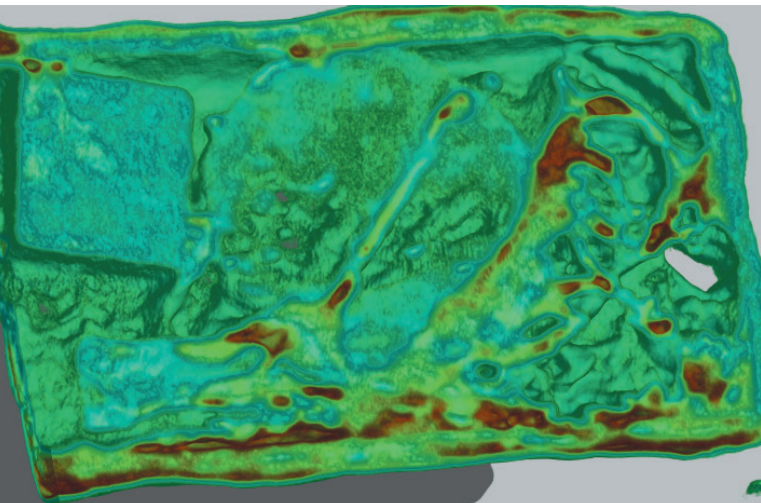

Fig. 1: An early neutron tomography picture (FRM, 1996). Right half of the bronze box, containing an early medieval weight (upper left), a balance (centre), and strings (right from the weight) from München Giesing, 6th century AD.

More than fifty years ago - or more specifically in 1957 - neutron activation analysis was introduced as one of the most important techniques for the chemical characterisation. Nowadays archeology uses not only the activation analysis but also the tomography in order to find answers to questions archeological finds of all periods raise. At the MLZ, the cooperation of archeologists and neutron scatterers looks back on quite a long time.

“Archaeometric research”, or “archaeological science”, represents the interface between archaeology and the natural and physical sciences. At the famous Atomic Egg it started in the Eighties when a combination of neutron activation analysis and Mössbauer spectroscopy, X-ray diffraction and thin-section microscopy was used. A small group under the direction of Ursel Wagner and Friedrich E. Wagner developed this very special combination and established it as a standard procedure aiming for the characterisation of archeological valuable ceramics. This method helped to cover two main topics of material analysis:

- the characterisation of the

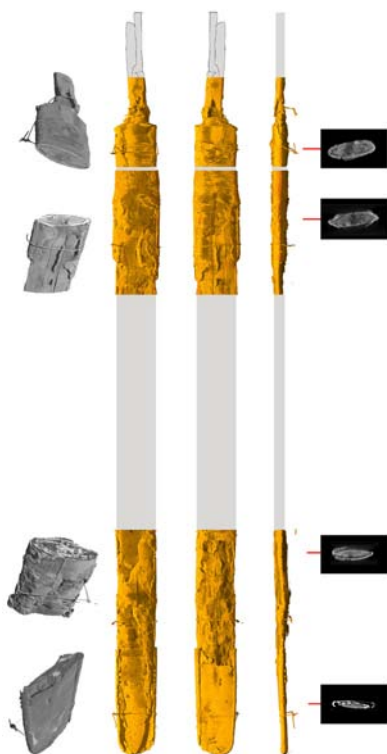

Fig. 2-3: Early medieval sword from Pforzen (Allgäu), 6th century AD. The different layers of the scabbard can be clearly depicted by neutron tomography. A strip of wood was detected under the bronze metal sheet that covers the scabbard's front side.

- the reconstruction of the technical details during the manufacturing process.

While neutron activation analysis, Mössbauer spectroscopy or other chemical analyses allow for the study of objects on a very detailed level, neutron tomography gives a general, non-destructive overview of the setting. In comparison to X-ray radiography, neutron radiography makes structures containing hydrogen clearly visible. Because the organic parts of many archeological objects had been destroyed during the long time of being buried, this method has its limitations in our field.

In 1996, the first archeological object was studied by neutron tomography in Garching. It was a bronze box from the early middle ages found in München-Giesing. 1400 years after it was locked, the stowed balance with a weight and some strings could be seen again (fig. 1).

The tradition of archeological studies continued at the FRM II. New instruments enlarged the possible areas of applications. The ANTARES facility allows for a view on objects with a much higher resolution. It became possible to study not only small textiles in detail but also whole large block-recoveries containing extensive remains of burials. Beside neutron tomography the prompt gamma activation analysis (PGAA) plays an important role for future analysis from then on, too.

A typical example for the advantage using neutrons in radiography is an iron sword excavated in Pforzen near Kempten dated from the 6th century AD. The iron blade is covered by a still existing sheath. This consists of several layers of partly mineralized organic material, which still contains small amounts of hydrogen. Because of this, neutrons help to produce an image especially of the organic parts, thus facilitating the reconstruction of the sword's original appearance. Neutron tomography can give extensive insights into the complete construction of the various layers of leather, wood, and strings. Even a piece of wood became visible, fixing the blade and covered by the



Fig. 4-5: Neolithic knife from Unfriedshausen, 3800-3500 BC. Neutron tomography allows for the virtual separation of flint, birch pitch, wood (from left to right).

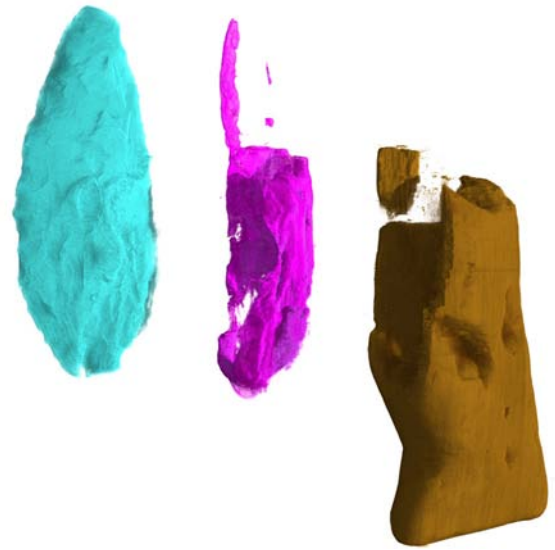

lower metal end of the scabbard (figs. 2-3). Using X-ray radiography here, only information on the blade and the iron fittings can be achieved.

Another example for the study of combined organic and anorganic materials where neutrons can give more detailed information than an X-ray study of the objects is illustrated in figs. 4 and 5. The object is a Neolithic knife with a wooden handle. The flint blade was inserted into the handle and in order to fasten it within, birch pitch was used as a glue. From the archaeologist's point of view it is really interesting to compare this partly hidden flint blade to other artefacts of this type, mostly classified as spearheads. Using neutron tomography, we see not only the knife's different parts, but gain also useful information for further typological studies on flint blades. Due to the different absorption it is possible to disassemble such an object virtually and to make the three main parts (in our case the wooden handle, the region of the glue and the blade) visible separately.

Beside such material research on the objects, conservation science seems to become an increasing field for the use of neutron techniques. The conservation of waterlogged wood or the study of chlorine content of corroded iron are only two examples for new applications. Archaeological wood or similar materials like leather are only preserved under special conditions. Waterlogged finds are totally saturated with water inside and thus can survive deterioration by the absence of air, light and oxygen. The main challenge for the conservation of those artefacts is to prevent the cell structures from collapsing during the drying process. This is often done by replacing the water by polyethylene glycol (PEG) and freeze-drying the object. PEG can seal it and therefore it is necessary that it comes through the whole object. The hydrogen of the PEG allows for a strong interaction with neutrons resulting in an image of the conservation substance within the object. At the moment, this method is the only non-destructive analysis tool for testing the

efficiency of the PEG treatment process.

The last example focusses on a central problem of preserving an innumerable amount of objects that are a core group of our cultural heritage: The conservation of iron artefacts is one of the biggest challenges in museums nowadays. While being buried, iron objects were exposed to reduced conditions and can therefore still be found in a rather well-preserved state. During a slow corrosion process chlorine solutions in the soil invaded them, an effect that has been increased during the last century by the use of fertilizers. Shortly after the excavation and in direct contact with fresh air, a quite rapid oxidation often sets in and manage to destroy the objects heavily. Chlorine is believed to contribute substantially to this corrosion by forming one of the iron corrosion products Akaganéite, which crystal lattice contains about 10% of Cl-ions. During a first conservation process efforts are made to extract the chlorine from the iron artefacts by bathing them in hydrous solutions of NaOH and sodium sulfite (Na_2SO_3). This process is normally supervised by determining the chlorine content of the leaching solutions. Often, there is a discrepancy between the already leached chlorine and that remaining in the object. At this point, a non-destructive analysis of the chlorine content in the object is needed. The problem could be solved using PGAA. It allows for a diagnosis of the chlorine content after excavation, as well as a study of the effectiveness of the leaching procedure, and further tests like the study of long-time stability. If this newly started project can be finished successfully, PGAA will be a very powerful analysis method for establishing strategies for conservation processes and supervising chemical treatments. The application of different analytic methods based on the special properties of neutrons can certainly improve our knowledge of the past in the nearest future.

R. Gebhard

(Archäologische Staatssammlung München)

Posi-Analyse

BMBF supports funding of positron instrumentation at the FRM II

In all kinds of technical materials lattice defects such as vacancies, dislocations or precipitates determine their mechanical, optical and electronic properties to a large extent. In solid state physics and materials science, the positron annihilation spectroscopy became an established non-destructive method for defect analysis on an atomic scale. There are various experimental techniques that profit from the high affinity of positrons to open-volume defects. Since an implanted positron typically diffuses over hundreds of lattice spacings prior to annihilation, the positron is an extremely sensitive nano-probe to detect vacancy concentrations as low as 0.1 ppm vacancies per atom. By variation of the positron's kinetic energy, a monoenergetic beam allows one to adjust the mean positron implantation depth up to several micrometers.

In 2012 the new **NE**utron induced **PO**sitron Source **MU**niCh (NEPOMUC) upgrade at the Forschungsneutronenquelle Heinz Maier-Leibnitz (FRM II) was successfully put into operation - hopefully you read the good news in the last newsletter. NEPOMUC provides the world highest intensity of monoenergetic positrons of $>10^9$ moderated positrons per second. The positron beam is used for a large variety of positron beam experiments in solid state and surface physics, materials science, and atomic physics.

The positron beam facility at NEPOMUC together with the positron instrumentation in the experimental hall of the FRM II can be explored in the picture. Close to the biological shield of the reactor the high intensity positron beam can be remoderated for brightness enhancement. A new beam switching device allows quick toggling between the primary high-intensity and the high-brightness remoderated positron beam. The positron beam is magnetically guided via a beam switch to five different positron instruments:

- **Positron annihilation induced Auger-Electron Spectroscopy – PAES:**
PAES has been demonstrated to be an excellent technique for the investigation of surfaces with top-most layer sensitivity.
- **(Coincident) Doppler-Broadening Spectroscopy – (C)DBS:**
DBS allows the examination of defects near the surface, in thin films and in the bulk up to a few μm as well as imaging of defect distributions with a lateral resolution of $300\mu\text{m}$. Additional element specific information in the surrounding of defects is gained by CDBS.
- **Pulsed Low-Energy Positron System – PLEPS:**
Vacancy-like defects in crystals and the free volume in amorphous materials can be studied by positron lifetime measurements at PLEPS.

- **Scanning Positron Microscope – SPM:**
Recently an experimental interface has been installed in order to enable the operation of a positron microscope for positron lifetime studies with enhanced lateral resolution.
- **Open Beam Port:**
Additional experimental set-ups can be connected to the positron beamline using the multi-purpose beam port.

Within the joint collaborative research initiative Posi-Analyse of the Universität der Bundeswehr München (UniBW), Technische Universität München (TUM), and Martin-Luther-Universität Halle (MLU) the positron instrumentation will be upgraded and extended using the high-intensity positron beam at FRM II. For the upcoming period 2013-2016, the BMBF (project no. 05K2013) grants funding for this research initiative, which is divided in four sub-projects:

Improvement of the Time Resolution of the Pulsed Positron Beam Facility PLEPS

G. Dollinger, UniBW

Due to the significant increase in beam brilliance at NEPOMUC upgrade it is possible to shorten the positron pulse lengths to 100 ps by an adequate adjustment of the beam pulsing and beam guidance in PLEPS. In order to improve the total time resolution of the system, it is also necessary to enhance the time resolution of the detectors of the annihilation radiation. The improved time resolution enables the separation and the identification of different atomic defects in metals and semiconductors with similar positron lifetimes with a wide range of applications in solid state physics and materials science.

Positron Beam with Micrometer Resolution for CDBS

Ch. Hugenschmidt, TUM

The overall objective of this sub-project is the implementation of a continuous positron micro-beam for CDBS with micrometer resolution. CDBS is complementary to positron lifetime spectroscopy as it is operated on PLEPS. The upgraded spectrometer will enable imaging of defect distributions in three dimensions with a lateral resolution in the micrometer range up to a depth of a few μm . In addition, elements can be identified near defects in order to characterise the chemical vicinity e.g. of vacancies.

Pulsed Positron Accelerator for Surface Studies at Low Temperature

Ch. Hugenschmidt, TUM

The surface spectrometer PAES will be equipped with a novel pulsed positron elevator, which allows to increase the potential energy of positrons without changing their

kinetic energy. Furthermore, a new low-temperature sample stage will be integrated. The new extensions of the spectrometer allow for the investigation of the energy and temperature dependent interaction of positrons with surfaces. In addition, surface processes such as surface segregation or heterogeneous catalysis can be studied with extremely high sensitivity to the topmost atomic layer.

Set-up of an In-situ Ion Source for Ion Beam Thinning and Ion Implantation

R. Krause-Rehberg, MLU

Objective of the proposal is to build a mobile ion source, which can be attached to the existing spectrometers CDBS and PLEPS at NEPOMUC. When using low-energy ions (<1 keV) at high currents, the samples can be thinned gradually with high accuracy. By ion milling, the

depth resolution for defect characterisation at interfaces, which are located in a depth much lower than 10 nm below the surface, can be increased. Furthermore, the ion source provides the ability to implant high-energy ions also (up to 50 keV) to allow for in-situ experiments of defect generation.

The planned instrumental development and the implementation of new devices at the various spectrometers enable to stand at the forefront in the research with positrons. The upgraded spectrometers will provide highly attractive experiments for internal as well as external scientific users using the high-intensity positron beam at NEPOMUC.

Ch. Hugenschmidt (TUM, FRM II)

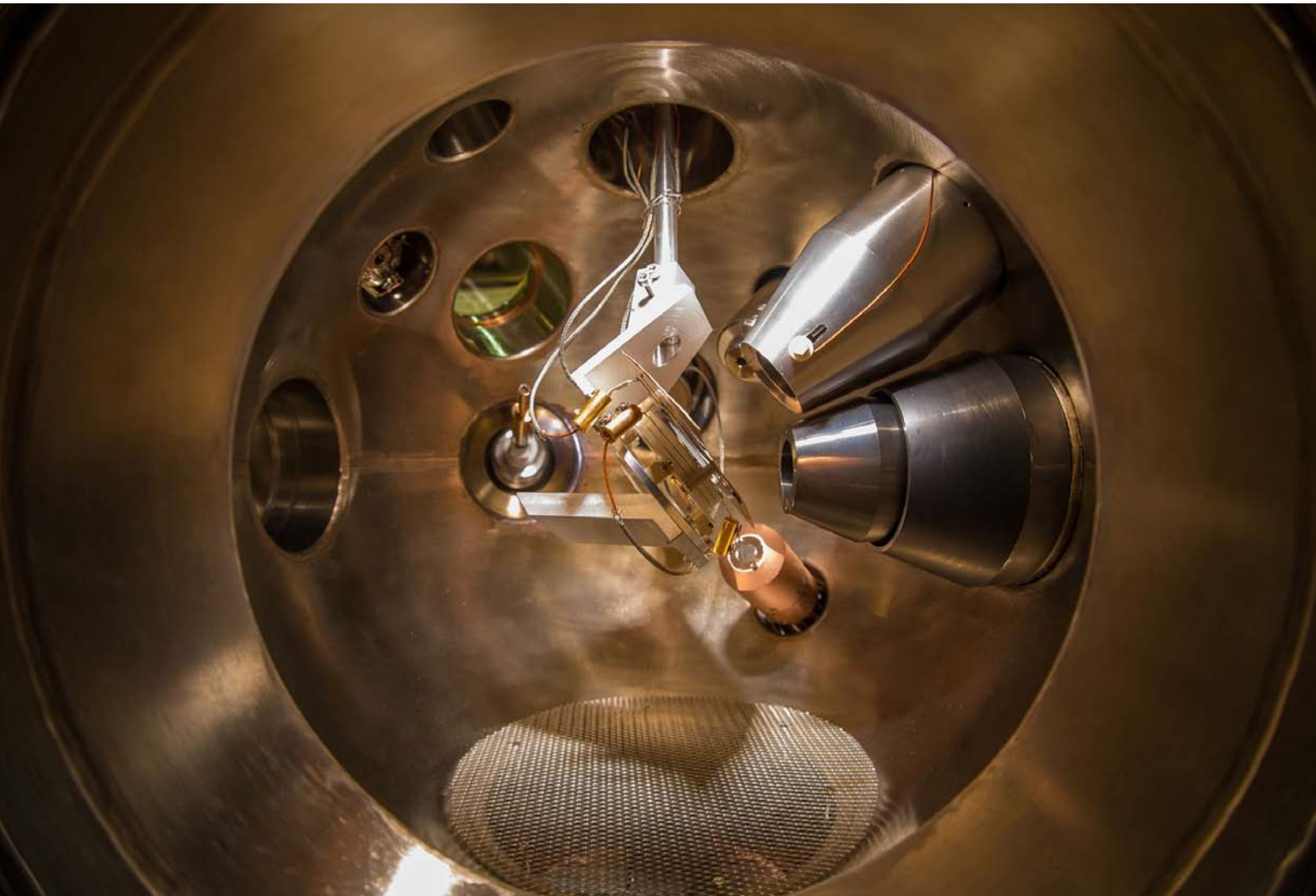

Vacuum chamber at the Positron annihilation induced Auger-Electron Spectrometer (PAES).

The funding of the collaborative research initiative by the BMBF (project no. 05K2013) is gratefully acknowledged

Neutronsources.org – Your Entry into the Neutron World!

New website launched

Neutronsources.org

Your entry into the neutron world

users' associations neutron centres
 the latest news contacts
 calendar of events reactor cycles
 neutron scattering tables projects
 software proposal deadlines
 RSS feeds info@neutronsources.org jobs

Since July 8th, the neutronsources.org website is online. This happened just on time for the *International Conference on Neutron Scattering (ICNS2013)* in Edinburgh where the launch was announced in the opening ceremony by Paul Attfield.

Neutronsources.org contains comprehensive and useful neutron-related information. On the website you can find a dedicated page for each world neutron centre and association with a description, pictures, important links and contacts. You can read the most recent news about scientific achievements and events in the neutron world. Those who are new in the field can browse the *Science with Neutrons* section to get to know more about neutrons, their characteristics and applications. Under *Resources* one can learn about projects and collaborations using neutrons, as well as useful neutron scattering software, tables, and educational material. On the *Calendar*, you can learn about future and past neutron events such as conferences, work-

shops and schools, including a list of frequent events like the European and International Conferences on Neutron Scattering. Have you got a brilliant idea for a research experiment? The website informs you about the facilities' deadlines for submission of proposals and also their operating periods. Are you looking for a job or need a change in your career path? You might find it on the up-to-date job openings lists on neutronsources.org.

All this is possible due to the enthusiasm of volunteers to create this website. A network of European press officers have been meeting to discuss the concept of the website, its content and outline since November 2011. There is currently a growing number of 37 facilities and users' associations contributing with the most up-to-date neutron-related information and news to the website. The content is coordinated by the NMI3 project and the server itself including technical support is provided by the FRM II.

By reusing previously published material such as news or events, the additional workload for press officers and contact persons from the involved institutions is kept to a minimum. The result is a lively portal that aims to become a reference to the neutron community. Would you like to contribute? All interested people are welcome to contact us at info@neutronsources.org!

I. Crespo (FRM II/NMI3), J. Neuhaus (FRM II)



Participants in the meeting (left to right): Angela Wenzik, Forschungszentrum Jülich GmbH; Françoise Vauquois, ILL; Miriam Forster, ILL/NMI3; Marianne Ekdahl, ESS; Margit Fábíán, BNC; Inês Crespo, FRM II/NMI3; Petra Riedel, FRM II.

A Strong German Commitment to the ESS is Needed!

This issue of the MLZ Newsletter presents a milestone of the German contribution to the upcoming European Spallation Source (ESS) project. Seven world class instruments have been proposed for the ESS in the current proposal round. This is a great success of the joint efforts of Helmholtz Centres, the Technische Universität München, and the German user community. Furthermore, it is a significant and bold step towards the aim of a sustainable and adequate German engagement at the ESS which is essential for research with neutrons in Germany but also and in particular for Germany's science and technology location.

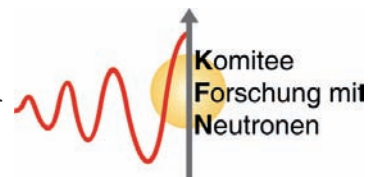

I strongly welcome this important positive sign. But we have to state that a rapid, considerable, and binding commitment of Germany to the ESS is still overdue. I would like to call on all persons in charge to find a way for a fast realisation of the ESS with an adequate German participation. The scientific need of the ESS has been demonstrated by numerous publications and underlined recently by the KFN report "Neutronenforschung für die wissenschaftlichen Herausforderungen der Zukunft" (cf. [1] which includes a link to the chapter on fundamental physics [2]). It is, however, the ongoing German discussion about the funding of operating costs of future large scale facilities which unsettles our European partners and – if not solved soon – might cause damage to the German reputation as a reliable partner for European large scale projects. This issue is not inherently linked to research with neutrons but has the potential to block any future investment in large scale infrastructure for research. In this context, a new format for cooperation between universities and the federal government of Germany is highly desirable and could help to overcome the current deadlock.

Nevertheless, I am very optimistic that a German commitment to the ESS will come soon and that the realisation of first projects will be presented at the SNI2014 conference which will take place in Bonn from September 21st to 23rd, 2014. Further highlights of this conference will be the celebration of the international year of crystallography and the German-Russian cooperation. For further information on the conference please visit our internet presence [3].

It is a tradition that another focus of the SNI conferences is on the presentation of the advances of the diverse collaborative research projects. In this year the new round of collaborative research projects started and it is a pleasure for me to state that neutron research was funded at a high level again.

In this year the KFN was very active again which can be realised by the short protocols of our three meetings in 2013. Please have a look and download them from the internet [4].

Now I thank all of you for your support and I wish you and your family a Merry Christmas and a peaceful beginning of the new year. I am looking forward to seeing you in the best health next year not later than at the SNI2014 in Bonn.



Tobias Unruh
Chairman of the 9th
Komitee Forschung mit Neutronen
(KFN)
Tobias.Unruh@fau.de

References

- [1] sni-portal.uni-kiel.de/kfn/Archiv/Neutronenforschung-2013.pdf
- [2] sni-portal.uni-kiel.de/kfn/Archiv/Neutronen_K-T.pdf
- [3] www.sni2014.de
- [4] sni-portal.uni-kiel.de/kfn/kfn/Protokolle.php

Newly Arrived

I am 2nd instrument scientist at PANDA. On my To-Do-list are experiments with users, then instrument development and also my own research.

I was PhD student in ILL, Grenoble for one year, and before I had been in Prague at Charles University, where I started my PhD.

Because of PANDA I am interested in everything with excitations in cold range of neutron spectra. It deals with strongly correlated electron systems, mainly superconductivity and heavy fermions. Furthermore, the instrumentation's software side thrills me: I found the NICOS team to be incredibly flexible and well working - thumbs up!



Petr Cermak

+49 (0)89 289 11773

p.cermak@fz-juelich.de

I started as a 2nd instrument scientist at the neutron thermal single crystal diffractometer RESI.

I had been at several European institutes as a postdoc and scientist: in Germany (HZB), Norway (IFE), and Switzerland (SINQ).

My scientific interest is focussed on understanding the functional properties of material (multiferroic, magnetic material, ferroelectric, hydrogen storage materials) in relation to their structure and dynamical properties using neutron and X-ray scattering (elastic and inelastic on powder and single crystal) essentially but not exclusively.



Nadir Aliouane

+49 (0)89 289 14661

nadir.aliouane@frm2.tum.de

I am joining JCNS as the 2nd instrument scientist responsible for the future time-of-flight spectrometer TOPAS. Currently we are building the instrument and we hope to have it operational shortly after we receive neutrons in the Neutron Guide Hall East.

After studying for my PhD and working through a PhD at University College London I moved to the **Australian Nuclear Science and Technology Organization (ANSTO)** in Sydney, Australia as a postdoc.

My main scientific interests centre around highly correlated magnetic materials and their study by neutron-based techniques.



Robert Aldus

+49 (0)89 289 11684

r.aldus@fz-juelich.de

Always be on the Safe Side!

Radiation protection and safety department approve all proposals

When you submit a proposal to one of our deadlines, many people at the MLZ will start their work on it. First of all, the User Office has a look at it, sorting everything out for the scientific review process. Our international casted review panels are working online for quite a while before they gather for the usual two day meeting, discuss the proposals live, and suggest the distribution of the available beam time. The directorate of the MLZ has to approve their suggestion and afterwards you are informed by an email about the results for each proposal. All proposers with an accepted proposal learn from their email, that the beam time is given with the reservation of the approval by our radiation protection department as well as our safety department. Did you ever wonder who they are and what they are looking for when reviewing your proposal?

Florian Jeschke of the radiation protection department is in charge of this task. He reads each proposal carefully and has a look at the sample description and the proposed sample environment. In case the sample is a nuclear fuel like Uranium or Plutonium, he is immediately alarmed. The Atomgesetz (AtG, German nuclear law), and special rules regarding the operation of the neutron research source FRM II regulate the handling of those materials. Furthermore, the EURATOM Safeguards are to be followed. For example: Even the smallest amount of Uranium must be reported to EURATOM, the European Atomic Energy Community.

Regarding other materials, metals are often a problem. Many of them will be activated very much during the experiment. This goes also for combinations of materials, often non-solid ones that are exposed to high temperature and/ or high pressure.

In order to review the proposals properly, the activation is calculated. For all nuclides, there are cross-sections which indicate the possibility of nuclear transformation. The chemical formula, neutron flux, duration of irradiation as well as the sample's mass are necessary for this calculation. It is then the basis for the measures of the radiation protection. They deal with the sample during irradiation: Maybe special isolation is stipulated or one has to take precautions against escaping of compressible fluids. A further aspect is the sam-

Florian Jeschke of the radiation protection department.

Ralf Lorenz of the safety department.

ple handling after the experiment. Either it will be reused or disposed. In the latter case it is really important that no nuclear waste is produced. If the user will

take care of the sample and transport it back to his home institution, it must not be radioactive (an exception is made in case the user/ his home institution has a license for handling radioactive substances. Although it is possible to store activated material at the FRM II, this can only be done for some weeks or a few months at the most. And how long does it take to check a proposal from the radiation protection's point of view?

"A well completed standard proposal form with all information we need? That will take three minutes. But in case information is missing and we have to query the main proposer, that sums often up to a few days.", guesses Florian Jeschke.

Ralf Lorenz of the safety department agrees with him. He checks the proposals regarding the work safety. He examines if the Labour Protection Law, the FRM II's operation manual, the Ordinance on Hazardous Substances as well as the Ordinance on Industrial Safety and Health are obeyed. Therefore, he has also a close look at the sample material: In case it is a CMR substance (that means carcinogenic, mutagenic and toxic to reproduction), he is really alerted. They can only be handled under consideration of special working instructions. He maybe advises the experimental team to wear gloves, glasses or similar parts of the personal protective equipment in case this will help to prevent contamination. However explosive material is allowed under no circumstances!

Both appeal to all users:

"Please keep always in mind that only approved proposals can be conducted. Therefore help us: Complete the proposal forms carefully and provide us with all information regarding the sample and the used sample environment. In case there are open questions we will write you an email - we kindly ask you to answer those emails as soon as possible!"

I. Lommatzsch (FRM II)



A Guided Tour of the Atomic Egg

Did you ever wonder what it looks like inside?



Powder diffractometer at beam tube P1.



"Experiment is running!" - in former times there was only a sign made of plastic or paper. Today, we have lights at each instrument.

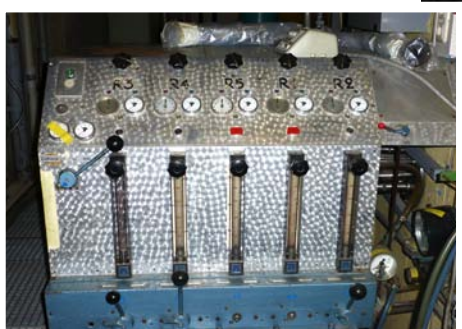

Here the rabbit system was loaded and unloaded.

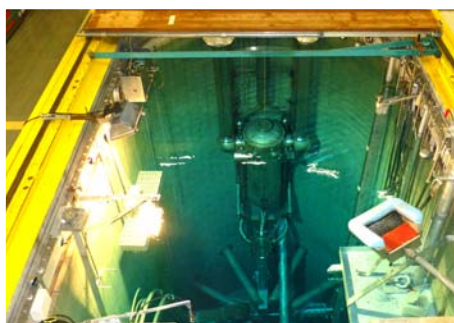

The reactor pool. You can see the beam tubes that delivered the neutrons to the experiments, and the cold source in the centre.



From here, the reactor was controlled.

Thank you for sharing your memories:
U. Kurz, J. Stephani, N. Waasmaier, Ch. Zeller (FRM II)



This was the control room of the cold source.

A look at the ceiling: The really beautiful but unfortunately impractical crane.

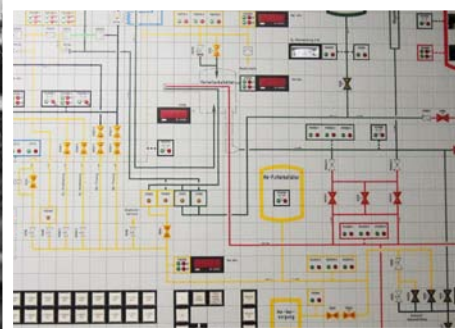

The cold source's control panel.

Guided by an institution: N. Waasmaier started working at the old FRM in 1961. He knows all the funny stories! The table lists the arrangement of the fuel elements in the core.



Information board: Is the reactor running? Is the beam on or off? Are the instruments being served? Are neutrons used for medical application?

Two Successful Rounds of our New Rapid Access Programme

Trying to serve our user community very well, the MLZ Directors decided to establish the MLZ Rapid Access programme to provide a fast procedure to access three instruments at the MLZ (KWS-2, PGAA and SPODI) when the regular access process could not be used. It is dedicated to special cases such as, for example, a material characterisation for tuning the preparation process or to complete a series of samples already measured for publishing the data.

Last July, the MLZ Rapid Access programme was launched with its first call for proposals to be measured during the reactor cycle between July 23rd and September 21st, 2013. The second Rapid Access proposal round took place in October 2013, and the accepted proposals received beam time during the reactor cycle between October 15th and December 14th, 2013.

The number of proposals received in the two proposal rounds was 21 requesting a total of 286 hours of beam time. Of them, 15 proposals were accepted for a total of 186 hours of beam time, that means a success rate of

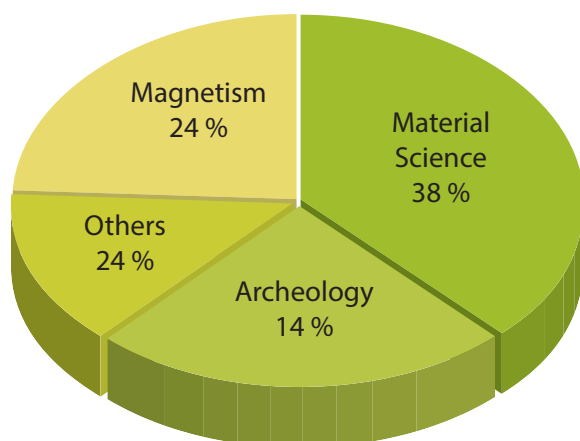

The topics of the Rapid Access programme so far.

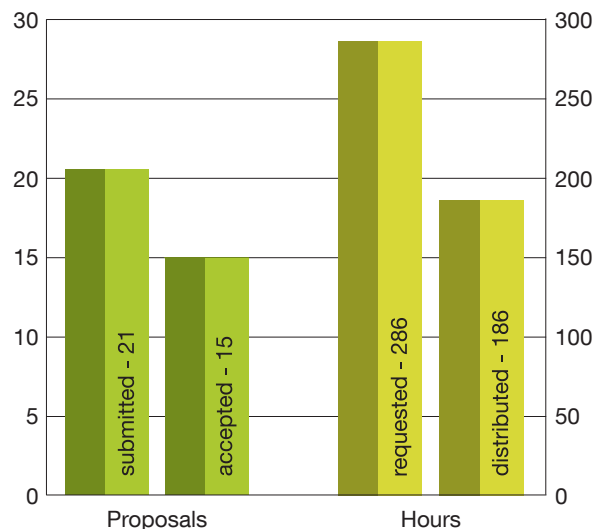

Request and acceptance of proposals and hours.

above 70%. The submitted proposals regarded mainly material science (38%), magnetism (24%) and archeology (14%), whereas the rest was shared among biology, crystallography, chemistry and condensed matter physics.

The next deadline for Rapid Access proposals is on January 7th, 2014. The accepted proposals will receive beam time during the next reactor cycle between January 14th and February 10th, 2014.

We kindly remind those users who got their samples measured within the MLZ Rapid Access programme to submit an experimental report. The lack of any experimental report will affect the decision on your future proposals.

Details on the MLZ Rapid Access programme are available on the MLZ web portal

mlz-garching.de/englisch/user-office/getting-beam-time as well as in the the current call on page 40.

Always on Fridays...

On February 10th, 2014, the FRM II will start a long maintenance break of around six months. This is inevitable: An March 2nd, 2004, the reactor went critically for the first time and ten years after this event, several tests are mandatory. We plan to be back again on August 19th, 2014. And in the meantime? Live will go on at the MLZ - and you can have a look at it with our new blog. It will be a valentine's Day present, because it will start on February 14th, 2014 - four days after the shut down. Always on Fridays, you will find an update about the ongoing work, a nice photo or just a little story about what we did at the User Office.

So - look forward and save the date! Of course we will send a circular email reminding you!

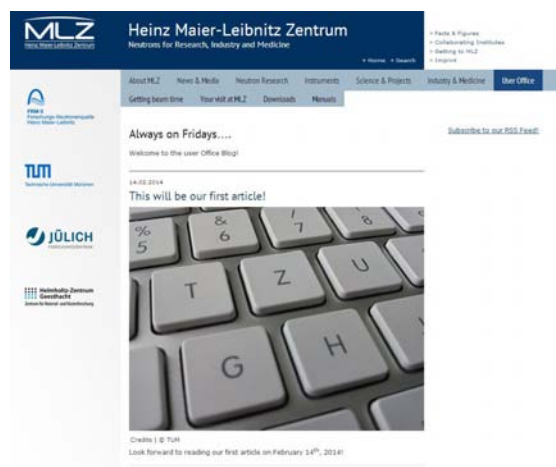

Review of Proposal Round 17

Ismaning, September 5th-6th

The second proposal round in 2013 turned out to be a great success for the MLZ. 352 proposals, requesting a total of 2320 beam days, were submitted until July 19th, and thus represent the largest number ever in any round at the MLZ.

Unfortunately, the number of available days was not as high as usually, mainly because of the shortened first reactor cycle (only 28 days) planned in 2014.

It already became autumnal, when the MLZ Review Panels' meeting took place on September 5th and 6th.

The reduced number of available days and the high quality of the submitted proposals yielded to a tough competition between the proposals. The decisions were not easy and therefore the Panels' members were really strained. In the end, the number of accepted proposals was 183, with an overbooking factor of 2.5.

Due to the large number of proposals in the last two proposal rounds that had been assigned to the Review Panel *Magnetism and Spectroscopy*, the MLZ Directors decided to share its workload between two subpanels, one for inelastic and one for elastic applications. This turned out to be a very successful decision, which highly improved the efficiency of the review process.

Another decision improved the number of available beam days. There were a few old proposals that had not yet performed any experimental sessions for lots of reasons. Instead, they prevented that new excellent proposals could be accepted. This situation was settled and therefore, the MLZ Directors terminated all never started external proposals accepted before January 1st, 2011. The main proposers received a letter from the User Office explaining this decision.

Please keep in mind that due to the long shutdown planned in the next year, only one proposal round is foreseen and the next proposal submission deadline is May 2nd, 2014!



Structure.

Imaging, Analysis and Nuclear and Particle Physics.



Soft Matter.



Material Science.



Magnetism A.



Magnetism B.



Biology.



Call for Rapid Access Proposals: Next Deadline January 7th, 2014

Beam time will be scheduled between January 14th and February 10th, 2014

We are pleased to announce the present call for proposals within the MLZ Rapid Access programme for the following **three instruments**

Instrument	Description	Neutrons
Diffraction		
SPODI	High resolution powder diffractometer	thermal
SANS and Reflectometry		
KWS-2	Small angle scattering	cold
Imaging		
PGAA	Prompt gamma activation analysis	cold



By a fast response process we will allocate up to a **maximum of 1.5 beam days** on each instrument in the next reactor cycle. Each accepted proposal can receive up to a **maximum of twelve hours** of beam time.

Proposal submitted after January 7th, 2014, will be considered for the next FRM II reactor cycle, i.e. August 2014.

The MLZ Rapid Access programme is **devoted** to those measurements, which do not fit into the normal proposal workflow with usually two deadlines and reviews per year, such as, for example, for tuning the preparation process or few samples to complete a series of sample measurements previously done.

In case a Rapid Access proposal is accepted, the user will **send the samples** to the designated local contact that carries out the proposed experiment and will take care of the sample handling/shipment back to the user. Due to the short duration of the measurements a **high degree of standardisation** is required and the usage of a complicated sample environment is excluded. It is expected that the measurements will be performed at **Standard Ambient Temperature and Pressure (SATP)** conditions by using a standard sample holder provided by the local contact. However, upon agreement with the local contact, the use of some simple sample environment equipment can be considered. The main proposer will be provided with **the raw experimental data as well as pre-treated data** for further analysis.



How to apply

- **Discuss** the proposed experiment with the instrument scientist well in advance – this step is mandatory!
- **Submit** a proposal via the User Office online system

user.frm2.tum.de

- for **PGAA** and **SPODI**

fzj.frm2.tum.de

- for **KWS-2**
- **Complete** all mandatory fields of the proposal form marked orange
- **Upload** the two page pdf file with all the technical and scientific details – you can download a template from mlz-garching.de/englisch/user-office/downloads
- Don't forget to **check** the checkbox *Rapid Access*!

Once the measurements have been carried out, please do not forget to upload all your experimental reports - please see more detailed information at mlz-garching.de/englisch/user-office/your-visit-at-mlz/home-again
Further information available at mlz-garching.de/englisch/user-office/getting-beam-time

Call for Proposals: Next Deadline May 2nd, 2014

Instrument	Description	Neutrons
Diffraction		
BIODIFF	Diffractionmeter for large unit cells	cold
HEIDI	Single crystal diffractometer	hot
MIRA	Multipurpose instrument	cold
POLI	Polarized neutron diffractometer	hot
RESI	Single crystal diffractometer	thermal
SPODI	High resolution powder diffractometer	thermal
STRESS-SPEC	Materials science diffractometer	thermal
SANS and Reflectometry		
KWS-1	Small angle scattering	cold
KWS-2	Small angle scattering	cold
KWS-3	Very small angle scattering	cold
MARIA	Magnetic reflectometer	cold
NREX	Reflectometer with X-ray option	cold
REFSANS	Time-of-flight reflectometer	cold
SANS-1	Small angle scattering	cold
Spectroscopy		
DNS	Diffuse scattering spectrometer	cold
J-NSE	Spin-echo spectrometer	cold
PANDA	Three axes spectrometer	cold
PUMA	Three axes spectrometer	thermal
RESEDA	Resonance spin-echo spectrometer	cold
SPHERES	Backscattering spectrometer	cold
TOFTOF	Time-of-flight spectrometer	cold
TRISP	Three axes spin-echo spectrometer	thermal
Imaging		
ANTARES	Radiography and tomography	cold
NECTAR	Radiography and tomography	fast
PGAA	Prompt gamma activation analysis	cold
Positrons		
NEPOMUC	Positron source, CDBS, PAES, PLEPS, SPM	-

Just **register** at the User Office online system. There you can access the proposal and reporting system. For additional information please have a look at mlz-garching.de/user-office

Proposals have to be **submitted** via the web portals within your personal account

- for FRM II, HZG, MPG instruments

user.frm2.tum.de

- for JCNS instruments

fzj.frm2.tum.de

The next **review** will take place on June 26th-27th, 2014. Results of that review panels' meeting will be online about two weeks later.

Financial Support

The FRM II is a partner in the EU supported network of European neutron facilities (NMI3-II in FP7). **Researchers working in EU Member States or Associated States** other than Germany can apply for travel and subsistence reimbursement.

Researchers working at German universities can apply for travel and subsistence reimbursement granted by the FRM II, JCNS, and HZG .

mlz-garching.de/englisch/user-office/your-visit-at-mlz/home-again

To ensure the **feasibility** of the proposed experiment please contact the instrument scientist in advance.

In addition to beam tube experiments, irradiation facilities are available for neutron activation analysis, isotope production and silicon doping.



Upcoming

March 10-21, 2014

45th IFF Spring School
Computing Solids: Models, Ab-initio Methods and Supercomputing
 (Jülich, Germany)
www.iff-springschool.de

March 30-April 4, 2014

DPG Spring Meeting of the Condensed Matter Section
 (Dresden, Germany)
dresden14.dpg-tagungen.de

Visit our booth there!

September 21-23, 2014

German Conference for Research with Synchrotron Radiation, Neutrons and Ion Beams at Large Facilities
 (Bonn, Germany)
www.sni2014.de

Preparations for Christmas...

Reactor Cycles 2014

No.	Start	Stop
30b	14.01.2014	10.02.2014
35	19.08.2014	17.10.2014
36	10.11.2014	12.12.2014



Imprint

Editors

Rainer Bruchhaus
 Flavio Carsughi
 Connie Hesse
 Christine Kortenbruck
 Ina Lommatzsch
 Jürgen Neuhaus
 Andrea Voit

Layout and Typesetting

Ramona Bucher
 Ina Lommatzsch

Picture Credits

If not indicated: By editors, authors and/ or FRM II.

W. Schürmann, TUM (1 below, 7 above, 15 right, 16 below and right, 17 above, 21 below, 33, 40 above right, 41)
 P. Ginther (5 above)
 H. Frielinghaus, JCNS (12, 19 above, 24)
 T. Gigl, FRM II (16 above)
 M. Offer, iserundschmidt (20 below)
 R. Eriksson, ESS (22 below)
 G. Martin, Oak Ridge National Laboratory (22 above)
 ESS (1 above, 23)

S. Mattauch, JCNS (25)
 K. Zeitelhack, FRM II (26)
 T. Demoulin, Archäologische Staatssammlung München (29 above right)
 M. Eberlein, Archäologische Staatssammlung München (29, above left)
 V. Dannert (31)
 S. Claisse, ILL (32)
 A. Radulescu, JCNS (40 above left)

Contact

Forschungs-Neutronenquelle
 Heinz Maier-Leibnitz (FRM II)
 User Office
 Lichtenbergstraße 1
 D-85747 Garching
 Phone: +49.(0)89.289.10794
 10703
 11751
 Fax: +49.(0)89.289.10799
 e-mail: useroffice@mlz-garching.de
www.mlz-garching.de



I. Lommatzsch (FRM II)

**Snow is falling
All around me
Excavators digging
Having fun**

...

...

Merry Christmas everyone!

SPONSORED BY THE



Federal Ministry
of Education
and Research

Bayerisches Staatsministerium für
Wissenschaft, Forschung und Kunst

